

TECNOAGUA

Design



2019

ENERO
CATÁLOGO - TARIFA
CATALOGUE - RATE

Desarrollo

Investigación

Estrategias

TECNO  **AGUA**
Design

***Nuevos
Productos***

Patentes

Innovación

Diseños

2019

***Ayudas
Humanitarias***

Certificaciones

***Líderes en
Innovación***

Moldes



Diseños

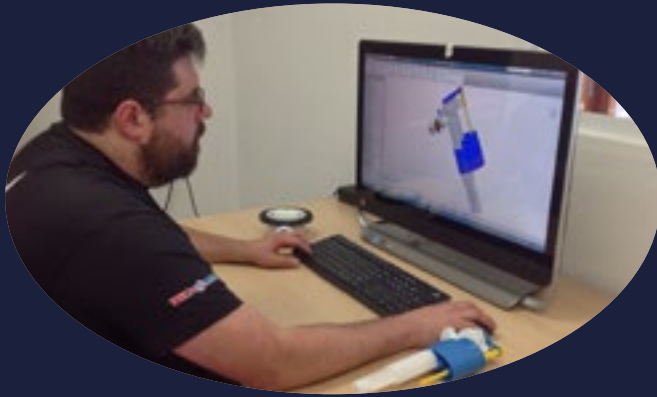

Logística

TECNOAGUA
Design



Control Calidad



Almacenes

Fabricación



Montajes



Ayuda

Humanitaria



Expediciones

Un equipo humano a su servicio

Nuestro valor es la constancia en la:

- **Innovación**
- **Calidad**
- **Servicio**



SOLIDARIA

Tú formas parte de ello

Rwanda

Nuestra presencia en **Hospital Nemba**



Estimado Cliente,

Desde nuestra empresa siempre hemos apostado por la máxima innovación, calidad y servicio. Gracias a vuestro esfuerzo, confianza y colaboración hoy somos lo que somos.

Pero por encima de todo, somos personas, y TECNOAGUA siempre ha aportado su granito de arena a nuevos proyectos sociales, deportivos y asistenciales.

Recientemente hemos emprendido un nuevo proyecto, el cual he apoyado personalmente en mi último viaje a **Rwanda**, donde tu fidelidad por TECNOAGUA se está transformando en ayuda humanitaria para los que más lo necesitan.

Por todo ello, quiero agradeceros que entre todos sigamos construyendo TECNOAGUA.



Rafael Morán Flaquer

Diseño, Fabricación y Comercialización



CERTIFICACIONES ISO 9001

Contactos Contacts

Pedidos	<i>Maribel Borragán</i>
Contabilidad	<i>Claudia Gómez</i>
Proveedores	<i>Gonzalo Ligero</i>
Facturación	<i>Esther González</i>
Coordinación	<i>Asunción Martínez</i>
Laboratorio	<i>Ezequiel Hurtado</i>
Jefe de Ventas	<i>Marcos Fernández</i>
Adjunta a Dirección	<i>Nuria Morán</i>
Director General	<i>Oscar Morán</i>
Presidente	<i>Rafael Morán</i>



Nuestra voz amable



Índice

Index

● CISTERNAS EMPOTRADAS Recessed Cisterns



Cisternas Empotradas
Recessed Cistern

10

● ACCESORIOS WC WC accessories



Mecanismos de descarga
Discharging mechanisms

16



Mecanismos de alimentación
Feed mechanisms

23



Tapas de inodoro
Toilet seats

28

● SIFONES Traps



Válvulas click-clack
Click-clack valves

34



Sifones sencillos
Single traps

38



Sifones dobles
Doble traps

48



Válvulas lavabo, bidé y fregadero
Sink and bidet valves

58



Accesorios
Accessories

60



Gama impermeabilización
Waterproofing

68



Válvulas plato de ducha y bañera
Bathtub and Shower tray valves

79



Sifones metalizados y cromados
Chromed and metallized traps

88



Botes sifónicos
Floor traps

98



Manguitos de Inodoro
WC Pan connectors

102

● DESAGUES DE SUELO Floor drains



Sumideros y calderetas
Floor drains and gullies

106



Canaletas
Channels

113

● ACCESORIOS DE PVC PVC Accessories



Serie evacuación
Drainage series

120



Conexiones
Connections

136

● FITTING Fitting



Fitting PPFV
Fitting PPFV

140



Collarines
Clamp

145



Válvulas esfera
Ball valve

146



Fitting latón
Brass fitting

148

● RECAMBIOS Spare parts

152

● ÍNDICE POR CÓDIGO Code index

162

**NOVEDAD
2019**



TECNOAGUA
Design

by

KARIBA[®]

Made in Italy - Since 1960

Cisternas Empotradas ***Un futuro cercano***

LA SENCILLEZ A TU ALCANCE

TecnoSMART



Estructura para anclaje a suelo y pared.



Equipada para su instalación en paredes de ladrillo o de placas de yeso laminadas



Cisterna con doble pulsador regulable entre 6 l. y 4,5 l.



Minimo espesor del mercado (80 mm. cisterna)



Rápido mantenimiento y regulación en 3 minutos.



Sencilla puesta en marcha en 10 minutos.

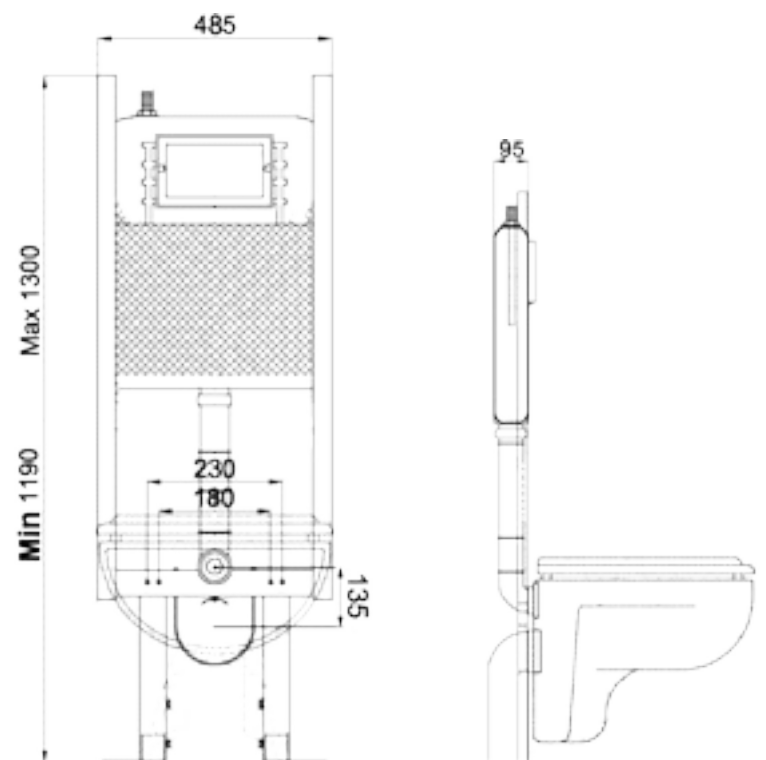

T-740

Cisterna empotrada TecnoSmart

Código: 50740 · U/C:1 - P.V.P.: 275,00 €

NOVEDAD

TecnoEKO



Estructura para anclaje a pared.



Equipada para su instalación en paredes de ladrillo.



Cisterna con doble pulsador regulable entre 6 l. y 4,5 l.



Mínimo espesor del mercado (80 mm. cisterna)



Rápido mantenimiento y regulación en 3 minutos.



Sencilla puesta en marcha en 10 minutos.

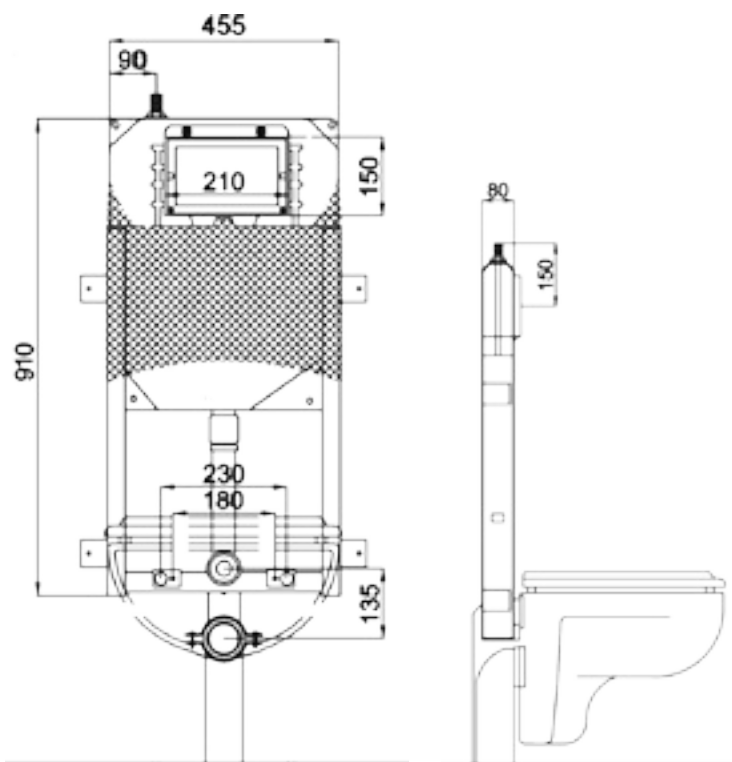

T-750

Cisterna empotrada TecnoEko

Código: 50750 · U/C:1 - P.V.P.: 225,00 €

NOVEDAD

TecnoLIGHT



Estructura para empotrar en obra.



Equipada para su instalación en paredes de ladrillo.



Cisterna con doble pulsador regulable entre 6 l. y 4,5 l.



Minimo espesor del mercado (80 mm. cisterna)



Rápido mantenimiento y regulación en 3 minutos.



Sencilla puesta en marcha en 10 minutos.

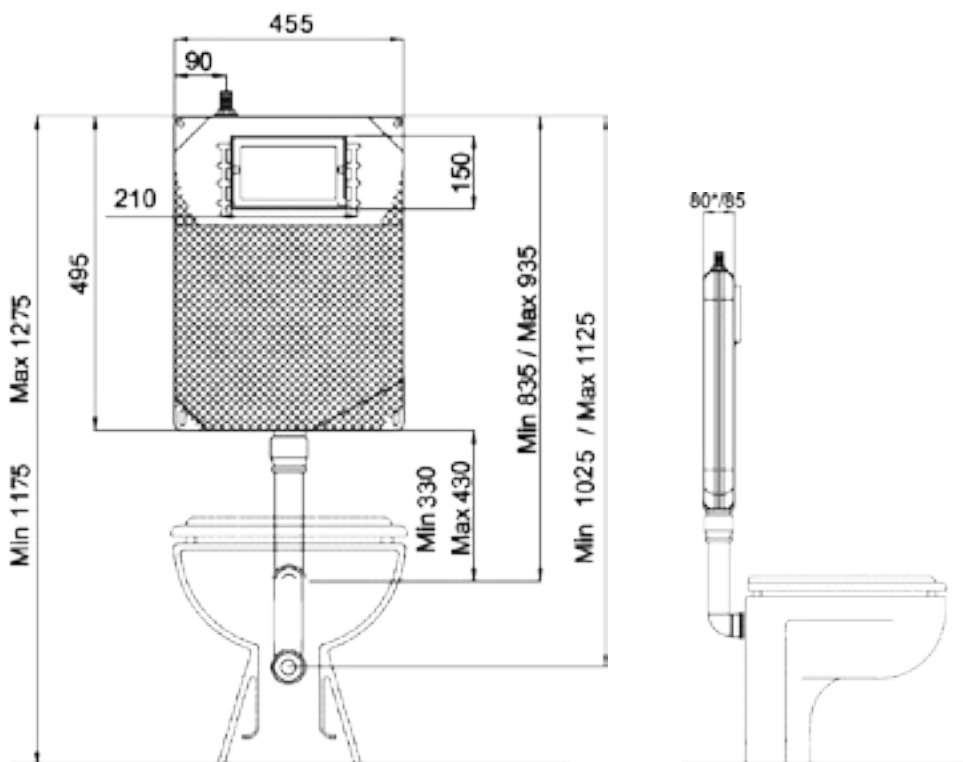

T-760

Cisterna empotrada TecnoLight

Código: 50760 · U/C:1 - P.V.P.: 175,00 €

NOVEDAD

Pulsadores (Medidas 240 x 160mm)

T-780B



BLANCO

Cód: 50731 U/C: 1 P.V.P.: 30,00 €

T-780S



CROMO SATINADO

Cód: 50732 U/C: 1 P.V.P.: 50,00 €

T-780C



CROMO BRILLO

Cód: 50733 U/C: 1 P.V.P.: 60,00 €

T-781B



BLANCO

Cód: 50736 U/C: 1 P.V.P.: 30,00 €

T-781S



CROMO SATINADO

Cód: 50737 U/C: 1 P.V.P.: 50,00 €

T-781C



CROMO BRILLO

Cód: 50738 U/C: 1 P.V.P.: 60,00 €

Recambios



Cód: 50790 P.V.P.: 20,00 €
Placa Soporte Pulsador



Cód: 50791 P.V.P.: 23,00 €
Grifo Flotador



Cód: 50792 P.V.P.: 14,00 €
Descargador



Cód: 50793 P.V.P.: 17,00 €
Soporte Descargador



Cód: 50794 P.V.P.: 17,00 €
Latiguillo



U/C: 10
Cód: 50707 P.V.P.: 11,00 €
Manguito Inodoro Recto Negro Ø90



U/C: 8
Cód: 50708 P.V.P.: 16,00 €
Codo Desagüe Inodoro Ø90



U/C: 15
Cód: 50709 P.V.P.: 10,00 €
Reducción Ø90-110



Cód: 50796 P.V.P.: 7,00 €
Membrana Descargador



Cód: 50797 P.V.P.: 2,00 €
Junta Soporte Descargador



Cód: 50798 P.V.P.: 25,00 €
Llave Regulación



Cód: 50786 P.V.P.: 4,00 €
Junta Conexión Desagüe



Cód: 50787 P.V.P.: 4,00 €
Junta Conexión Inodoro



Cód: 50788 P.V.P.: 3,00 €
Tirador Descargador

**NOVEDAD
2019**



**PRÓXIMO
LANZAMIENTO**

● **Grifo VH Dual
by Piston**

Mecanismos Cisterna

Cistern mechanism



Generamos Seguridad

Próximo Lanzamiento

Doble Pulsador



Antivandálico



PATENTADO

T-285

Mecanismo universal doble descarga por pulsador + KIT ANTIVANDÁLICO

T-280 S

Sin KIT

T-280

Con KIT

Mecanismo universal doble descarga por cable
 Código: 50771 - U/C: 16 - P.V.P.: 28,19 €

Mecanismo universal doble descarga por cable + KIT
 Código: 50770 - U/C: 16 - P.V.P.: 30,69 €

Doble Pulsador

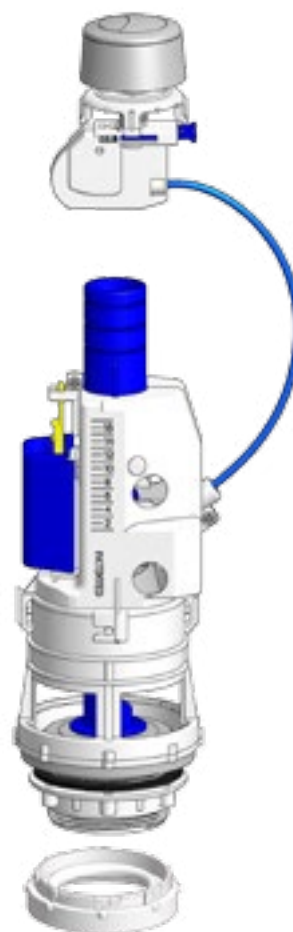
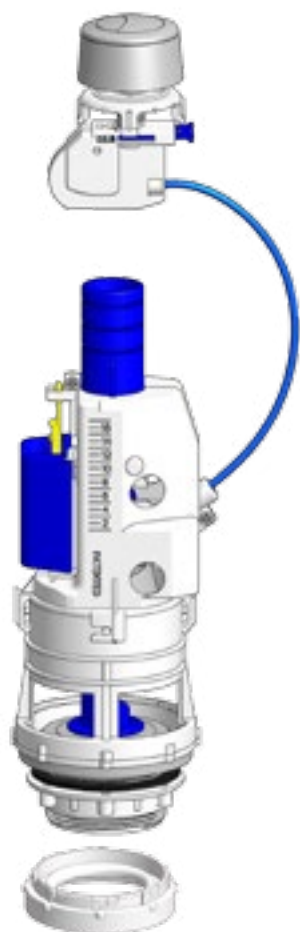

PATENTADO

UNIVERSAL
Se Adapta a:



BASE
TECNOAGUA



BASE
BAYONETA



BASE
ROSCADA



BASE CAMPANA
ANTIGUA



BASE CAMPANA
NUEVA

T-282 NS

Sin KIT

Mecanismo universal doble descarga por pulsador
Código: 50775 - U/C: 15 - P.V.P.: 26,63 €

T-282 N

Con KIT

Mecanismo universal doble descarga por pulsador + KIT
Código: 50774 - U/C: 15 - P.V.P.: 29,13 €

Doble Pulsador

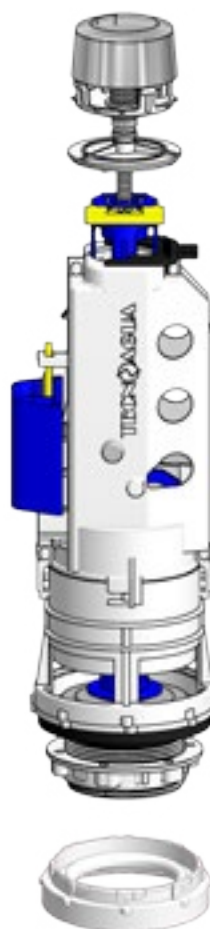

PATENTADO



UNIVERSAL
Se Adapta a:



BASE
TECNOAGUA



BASE
BAYONETA



BASE
ROSCADA



BASE CAMPANA
ANTIGUA



BASE CAMPANA
NUEVA

T-281 NS

Sin KIT

Mecanismo universal simple descarga por pulsador
 Código: 50773 - U/C: 15 - P.V.P.: 18,65 €

T-281 N

Con KIT

Mecanismo universal simple descarga por pulsador + kit
 Código: 50772 - U/C: 15 - P.V.P.: 21,15 €

Interrumpible



Pulsador Simple



PATENTADO



UNIVERSAL
 Se Adapta a:



BASE
 TECNOAGUA



BASE
 BAYONETA



BASE
 ROSCADA



BASE CAMPANA
 ANTIGUA



BASE CAMPANA
 NUEVA

Simple pero elegantes

Modelos para Tirador



T-289 S Sin KIT

Mecanismo simple descarga por tirador

Código: 50875
U/C: 30
P.V.P.: 9,95 €



T-289 Con KIT

Mecanismo simple descarga por tirador + kit

Código: 50874
U/C: 30
P.V.P.: 12,45 €



T-289 SS Simple

Mecanismo simple descarga por tirador

Código: 50889
U/C: 30
P.V.P.: 7,50 €



T-289 R Básico

Recambio mecanismo simple descarga por tirador

Código: 50880
U/C: 30
P.V.P.: 5,75 €

Se Adapta a:



PATENTADO

LO QUE ESTABAS ESPERANDO

Grifo VH DUAL

by Piston

Un todoterreno

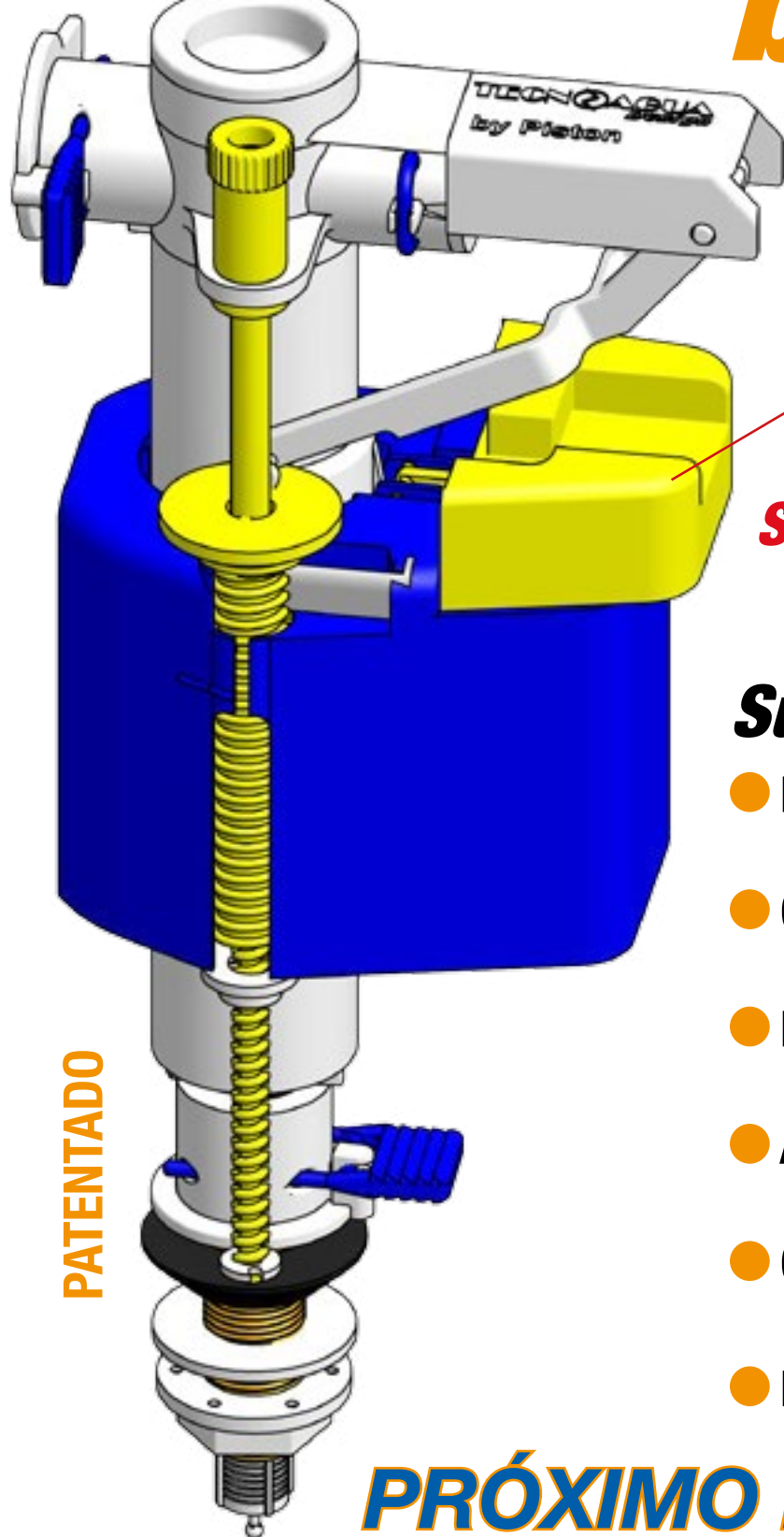

SU CORAZÓN

Boya Bloqueadora

Sus ventajas

- Máximo caudal constante
- Corte de caudal instantaneo
- Para altas y bajas presiones
- Amplio paso de agua
- Cuando el filtro no es suficiente
- Para aguas duras

PATENTADO

PRÓXIMO LANZAMIENTO

T-468

Grifo Cisterna Alimentación VH Dual by Piston
Código: 50768 · U/C:20 - P.V.P.: 18,82 €

Grifos Cisterna Alimentación

Grifo VH DUAL *HORIZONTAL - VERTICAL*

LO QUE NOS DIFERENCIA:

- Convertible en 10 segundos
- Regulación instantánea de la boya
- Fácil acceso a membrana
- Rápida regulación en altura
- Fabricado en resina acetálica (P.O.M.)
- Compacto
- Seguro

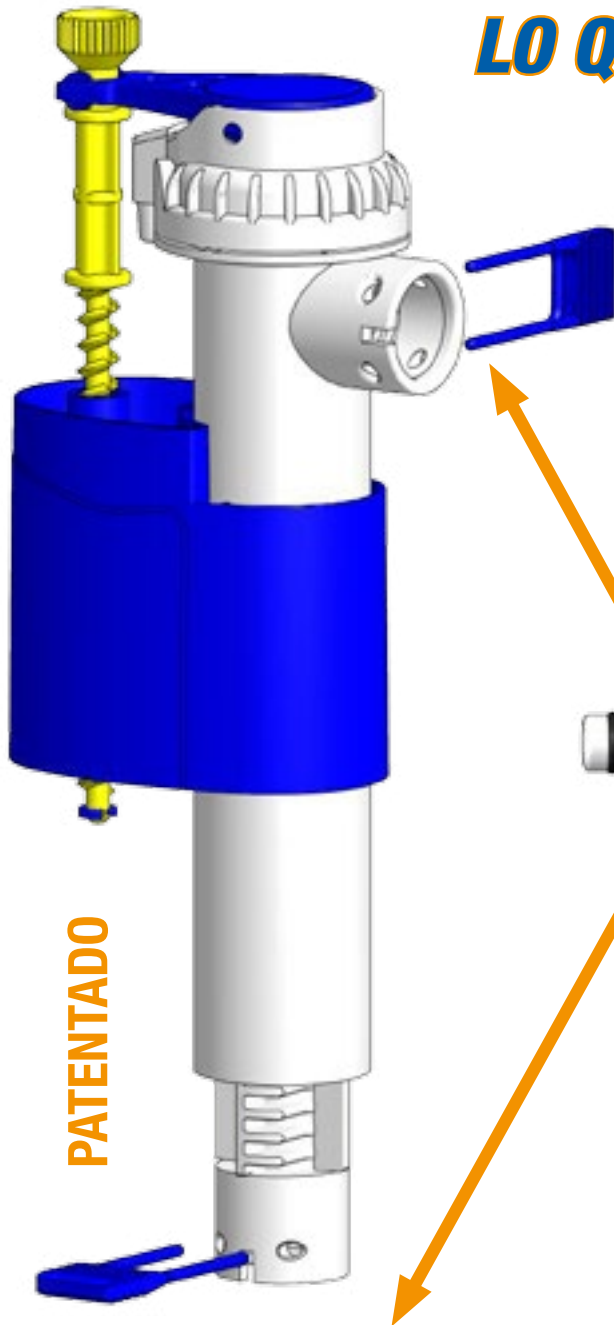

SISTEMA

PUSH - PULL



Conexión a tanque



Tapón cierre



Horquilla Fijación

T-469

Grifo Cisterna Alimentación VH Dual

Código: 50769 · U/C:40 - P.V.P.: 18,82 €

Horizontal

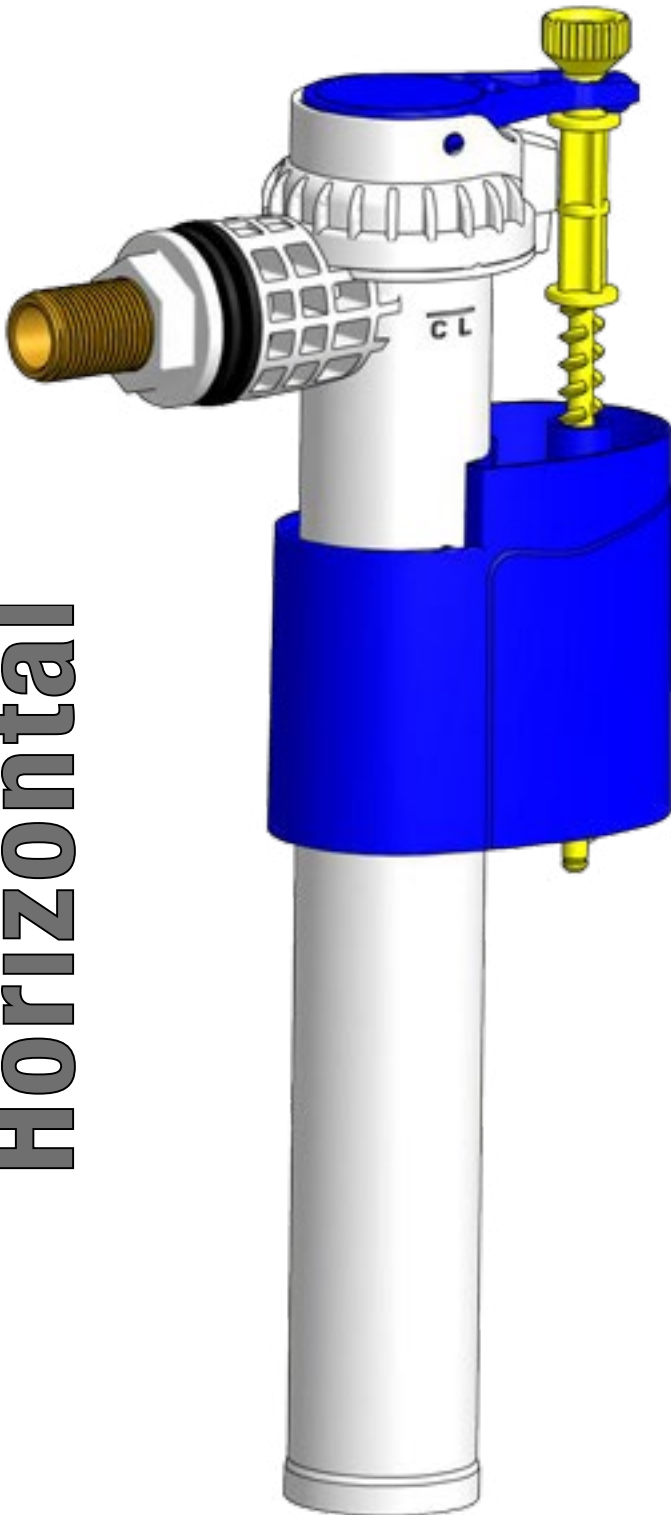

T-461

Grifo cisterna alimentación horizontal

Horizontal cistern tap

Código: 50635 - U/C: 26

P.V.P.: 17,10 €

Vertical

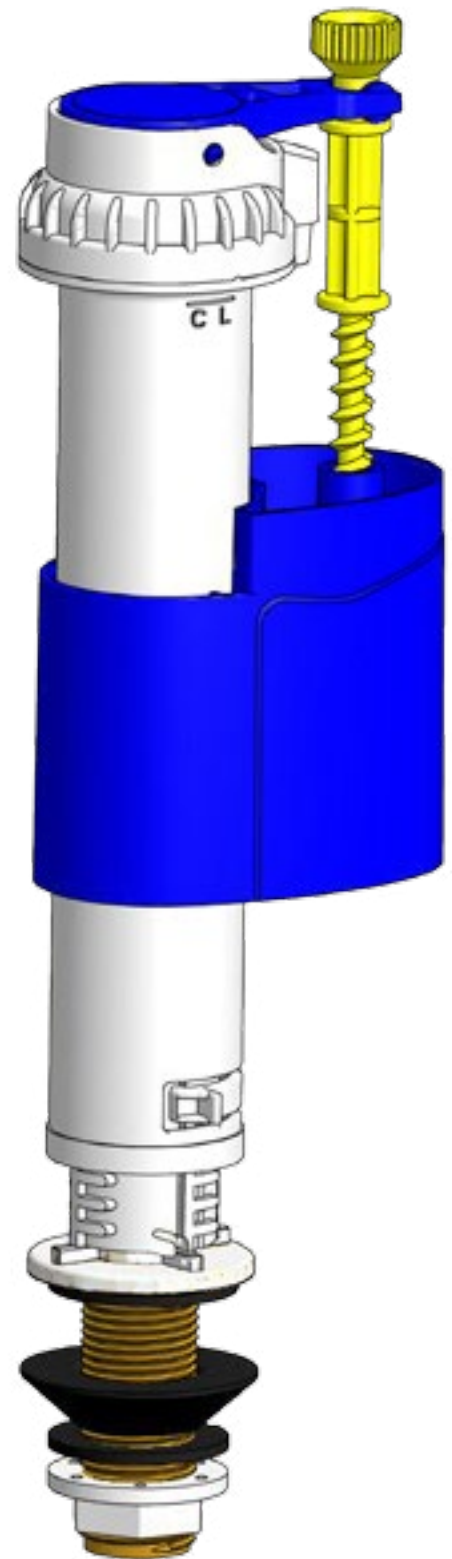

T-451

Grifo cisterna alimentación vertical

Vertical cistern tap

Código: 50634 - U/C: 44

P.V.P.: 17,10 €

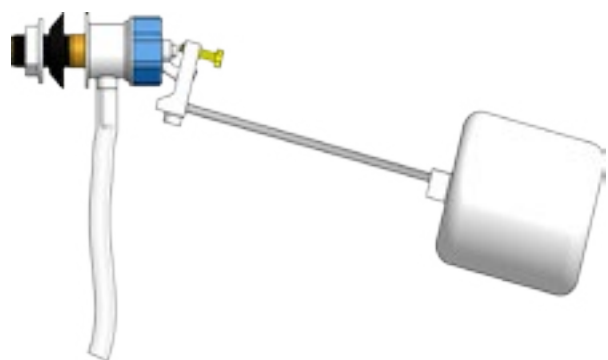

T-462

Grifo Cisterna Boya PISTON Alimentación HORIZONTAL

VERTICAL PISTON tap Cisterna

Código: 50735 - U/C: 25 - P.V.P.: 6,25 €



T-452

Grifo Cisterna Boya PISTON Alimentación VERTICAL

VERTICAL PISTON tap Cisterna

Código: 50734 - U/C: 25 - P.V.P.: 9,25 €

PRÓXIMAS NOVEDADES EN CURSO



“LA INNOVACIÓN, NUESTRA META”

Recambios Mecanismos

Spare parts

Para orificios Ø14 a 45mm



T-280 P

Código: 50886
U/C: 12
P.V.P.: 7,65 €

Pulsador doble para T-280

Para orificios Ø14 a 45mm



T-281 P

Código: 50877
U/C: 12
P.V.P.: 4,08 €

Pulsador simple para T-281

Para orificios Ø14 a 45mm



T-282 P

Código: 50869
U/C: 12
P.V.P.: 7,65 €

Pulsador doble para T-282

Suplemento hasta Ø62mm



T-279

Código: 50279
U/C: 25
P.V.P.: 2,25 €

NOVEDAD

Adaptador para orificios gigantes



T-289 T

Código: 50878
U/C: 40
P.V.P.: 5,62 €

Tirador para T-289



T-294

Código: 50619
U/C: S/P
P.V.P.: 0,70 €

Membrana descarga



T-293

Código: 50888
U/C: S/P
P.V.P.: 1,91 €

Adaptador base rosca

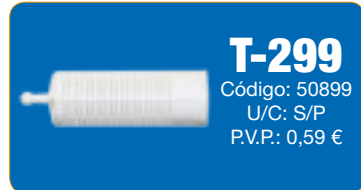

T-299

Código: 50899
U/C: S/P
P.V.P.: 0,59 €

Filtro grifo cisterna



T-295

Código: 50895
U/C: S/P
P.V.P.: 1,91 €

Campana base mecanismos



T-296

Código: 50896
U/C: S/P
P.V.P.: 2,22 €

Base mecanismos



T-297

Código: 50897
U/C: S/P
P.V.P.: 0,92 €

Junta base mecanismos



T-298

Código: 50898
U/C: S/P
P.V.P.: 0,70 €

Membrana grifo alimentación

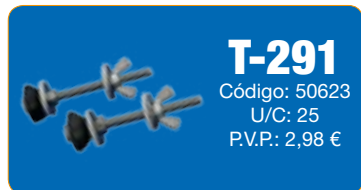

T-291

Código: 50623
U/C: 25
P.V.P.: 2,98 €

Tornillo fijación inox.



T-292

Código: 50650
U/C: 20
P.V.P.: 1,51 €

Junta estanqueidad tanque CAUCHO



T-291 K

Código: 50867
U/C: 10
P.V.P.: 4,77 €

Kit fijación (tornillos inox.) + Junta estanqueidad CAUCHO



T-290

Código: 50730
U/C: S/P
P.V.P.: 1,03 €

NOVEDAD

Tapón Lateral Cisterna CROMADO



T-277

Código: 50277
U/C: 15
P.V.P.: 1,75 €

NOVEDAD

Multi Junta estanqueidad FOAM
Ø111 - Ø82 - Ø56





T-278K

Código: 50278
U/C: 10
P.V.P.: 4,99 €

NOVEDAD

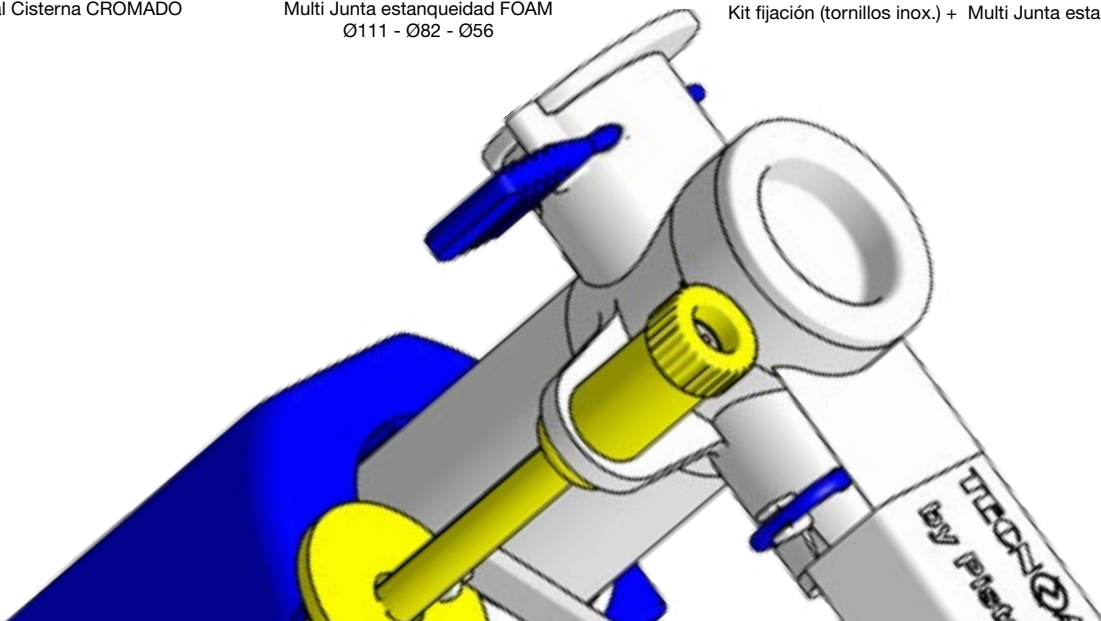
Kit fijación (tornillos inox.) + Multi Junta estanqueidad FOAM



The image features two white toilet seats against a vibrant blue background with dynamic, glowing light streaks. The top seat is shown from a side-on perspective, highlighting its stainless steel hinges. The bottom seat is shown from a similar angle but with a different hinge design.

SISTEMA
INOX Click

SISTEMA
Easy Click

Tapas Inodoro Universales Amortiguadas

Toilet Seats



SISTEMA Easy Click



Recambio tornillos Sistema EASY CLICK

SISTEMA INOX Click



Recambio tornillos Sistema INOX CLICK



**TODAS LAS TAPAS
AMORTIGUADAS**

*Y CON TORNILLERÍA DE
SISTEMA EXPANSIVO*

SUACES 50267



Recomendado:

- ® VERANDA*
- ® AMERICA*

U/C: 8
P.V.P: 40,81€

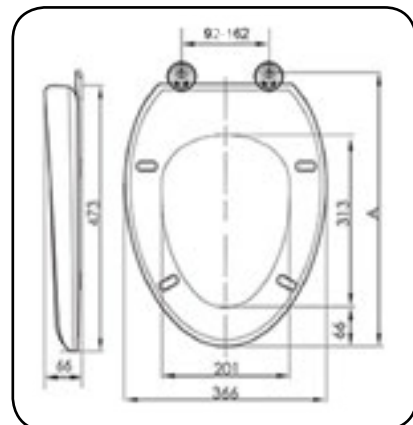

INOX Click

TABARCA 50627



Recomendado:

- ® VICTORIA*
- ® LUCERNA*

U/C: 8
P.V.P: 33,52€

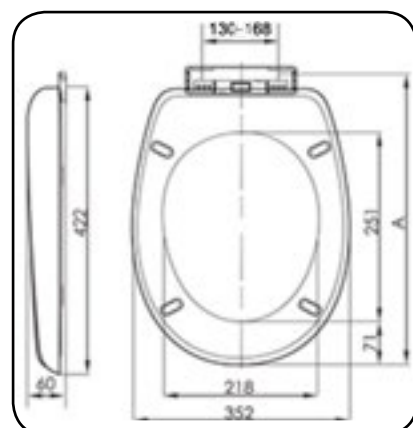

Easy Click

IBIZA 50625



Recomendado:

- ® VICTORIA*
- ® LUCERNA*

U/C: 8
P.V.P: 30,39€

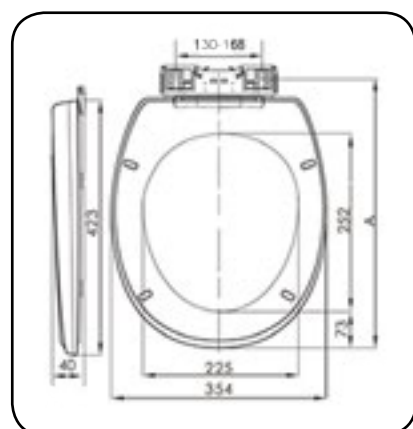

Easy Click

ALEGRANZA
50269



Recomendado:
® HAPPENING*

U/C: 8
P.V.P: 46,17€

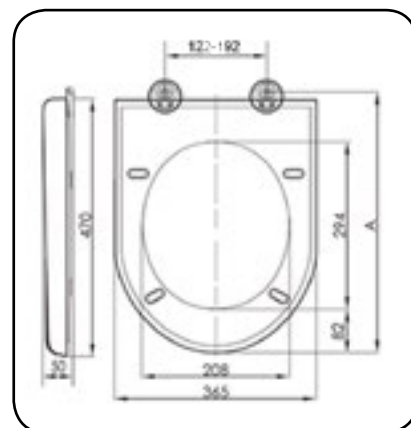

INOX Click

AROSA
50268



Recomendado:
® MERIDIAN*
® CIVIC*

U/C: 8
P.V.P: 39,00€

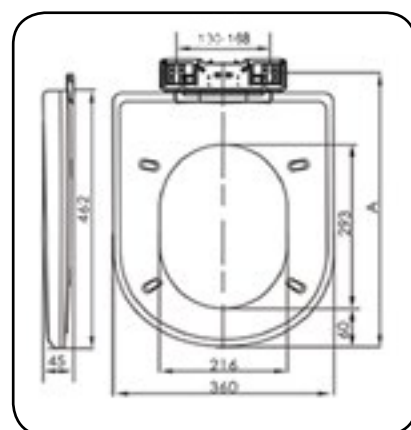

Easy Click

LUCENTUM
50626



Recomendado:
® DAMA RETRO*
® ACCESS*

U/C: 8
P.V.P: 33,88€

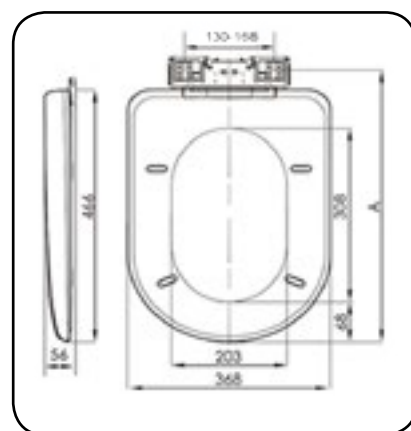

Easy Click

*Las denominaciones anteriores son Marcas ® registradas por compañías no relacionadas con HIDROTECNOAGUA, S.L.

RONDELLA 50265



Recomendado:

® DAMA*

U/C: 8
P.V.P: 48,54€

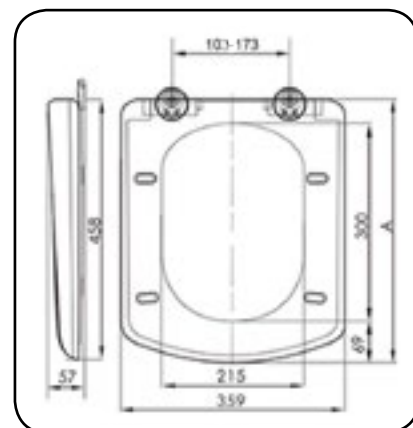

INOX Click

MEDAS 50264



Recomendado:

® GAP*

® FRONTALIS*

U/C: 8
P.V.P: 42,97€

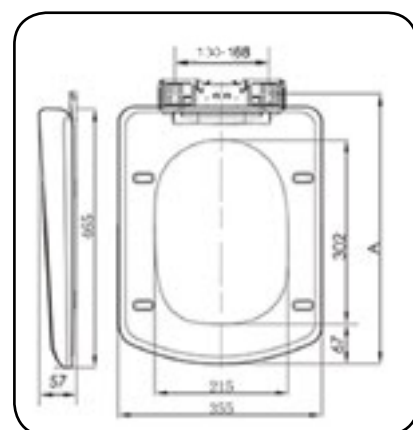

Easy Click

DEVA 50263



Recomendado:

® DEBBA*

U/C: 8
P.V.P: 35,48€

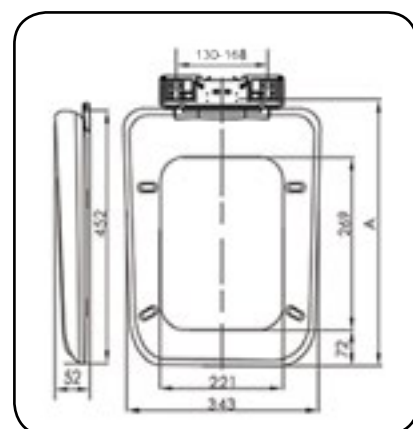

Easy Click



MONTA UNA **TECNO CLICK-CLACK**
Y LIBÉRATE DE LAS CADENAS

Serie Click - Clack

Click - Clack Series



T - 303

Código: 50303 - U/C: 28 - P.V.P.: 8,77 €



- **KIT TOTALMENTE MONTADO**
- **RÁPIDA INSTALACIÓN**

ORDEN DE MONTAJE

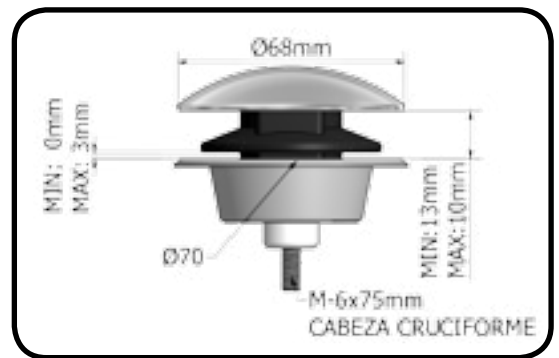

Serie Blanca **TECNO CLICK-CLACK**

T - 30M Clack

T - 2M Clack

T - 60 Clack



Código: 50108 - 1½ - 1¼
U/C: 8
P.V.P.: 12,64 €



Código: 50109 - 1½
Código: 50112 - 1¼
U/C: 10
P.V.P.: 12,99 €



Código: 50110 - 1½
Código: 50111 - 1¼
U/C: 20
P.V.P.: 10,01 €

Click Clack Latón-Cromo Estandar

T - 301 N

Código: 50103 - U/C: 20
P.V.P.: 21,33 €



COMPLETA



T - 301 NR

Código: 50104 - U/C: 20
P.V.P.: 16,82 €



RECAMBIO

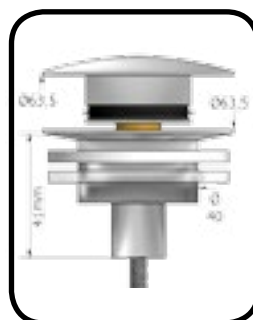

T - 302

Código: 50106 - U/C: 20
P.V.P.: 17,94 €



* Medidas Válvula T-60 1¼
Consultar Página 48

Click Clack Latón-Cromo Plana

T - 304 N

Válvula Click-Clack latón plana

Código: 50100
U/C: 20
P.V.P.: 18,64 €



COMPLETA

T - 304 NR

Válvula Click-Clack latón plana

Código: 50101
U/C: 20
P.V.P.: 14,19 €



RECAMBIO

Recambios



T-304 X

Código: 50113
U/C: S/P
P.V.P.: 3,08 €

Repuesto accionamiento Click-Clack latón

SERIE PLANA



T-301 X

Código: 50107
U/C: S/P
P.V.P.: 3,08 €

Repuesto accionamiento Click-Clack latón

SERIE ESTANDAR



T-303 R

Código: 50302
U/C: S/P
P.V.P.: 5,25 €

Embellecedor Plástico

TECNO CLICK-CLACK



TECNOAGUA

Sifones Sencillos

Single traps







Equipo de regatas

TECNOAGUA
Design

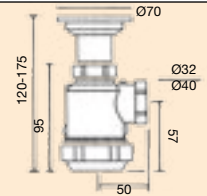



Minivolumen



REF.	SALIDA	CÓDIGO	APLICACIÓN	COTAS	ENTRADA	U/C	PVP €
REF.	OUTLET	CODE	APPLICATION	DIMENSIONS	INLET	U/Box	€/pc
T-2M	1¼	50010			 Registro Cónico	60	5,38
T-2M	1½	50011	 			Ø70	60

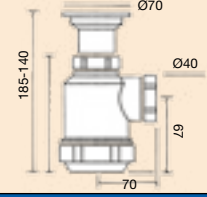

SIFÓN BOTELLA EXTENSIBLE
EXTENSIBLE BOTTLE TRAP



T-2	1½	50000	  		 Ø70	50	5,74
-----	----	-------	---	---	--	----	------

SIFÓN BOTELLA EXTENSIBLE
EXTENSIBLE BOTTLE TRAP

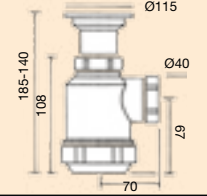





T-2E	1½	50002			 Ø115	75	7,80
------	----	-------	--	--	---	----	------

SIFÓN BOTELLA EXTENSIBLE
EXTENSIBLE BOTTLE TRAP

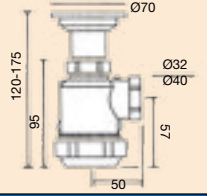



Minivolumen



T-3M	1¼	50021			 Registro Cónico	60	6,50
T-3M	1½	50022	 			Ø70	60

SIFÓN BOTELLA EXTENSIBLE CON CADENA
EXTENSIBLE BOTTLE TRAP WITH CHAIN

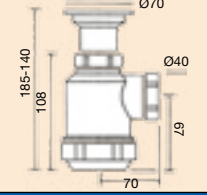





T-3	1½	50020	  		 Ø70	50	6,87
-----	----	-------	---	---	--	----	------

SIFÓN BOTELLA EXTENSIBLE CON CADENA
EXTENSIBLE BOTTLE TRAP WITH CHAIN

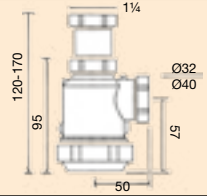
Minivolumen



T-4M	1¼	50025			 Registro Cónico	80	3,58
T-4M	1½	50026	 			1¼	80

SIFÓN BOTELLA EXTENSIBLE CON TUERCA LOCA
EXTENSIBLE BOTTLE TRAP WITH SLIP NUT



REF.	SALIDA	CÓDIGO	APLICACIÓN	COTAS	ENTRADA	U/C	PVP €	
REF.	OUTLET	CODE	APPLICATION	DIMENSIONS	INLET	U/Box	€/pc	
T-4	1½	50041				1½	60	3,61
SIFÓN BOTELLA EXTENSIBLE CON TUERCA LOCA <i>EXTENSIBLE BOTTLE TRAP WITH SLIP NUT</i>								



T-4VA	1½	50030				1¼	60	3,72
SIFÓN BOTELLA EXTENSIBLE PARA VÁLVULAS AUTOMÁTICAS <i>EXTENSIBLE BOTTLE TRAP FOR AUTOMATIC VALVES</i>								



T-4L	1½	50050				Ø40	60	3,75
SIFÓN BOTELLA PARA RECIBIR TUBOS LISOS <i>BOTTLE TRAP WITH CONNECTION FOR SMOOTH PIPES</i>								



T-4T	1½	50051				1½	40	4,79
SIFÓN BOTELLA EXTENSIBLE CON TOMA DE LAVADORA <i>BOTTLE TRAP WITH CONNECTION FOR WASHING MACHINE</i>								



T-4TD	1½	50042				1½	40	5,49
SIFÓN BOTELLA EXTENSIBLE CON DOBLE TOMA DE LAVADORA <i>EXTENSIBLE BOTTLE TRAP WITH DOUBLE CONNECTION FOR WASHING MACHINE</i>								



T-5	1½	50043			Registro Cónico			
SIFÓN BOTELLA PARA PILAS DE GRANITO <i>BOTTLE TRAP FOR GRANITE SINK</i>						Ø32	40	8,14



REF.	SALIDA	CÓDIGO	APLICACIÓN	COTAS	ENTRADA	U/C	PVP €
REF.	OUTLET	CODE	APPLICATION	DIMENSIONS	INLET	U/Box	€/pc
T-2ER	1½	50005				45	12,21
SIFÓN BOTELLA EXTENSIBLE CON REBOSADERO							
<i>EXTENSIBLE BOTTLE TRAP WITH OVERFLOW</i>							



T-11	1½	50068			Registro Cónico	Ø70	60	5,90
SIFÓN Y GRIEGA PARA PILAS DE GRANITO								
<i>"Y" TRAP FOR GRANITE SINK</i>								



T-8	1½	50056			Registro Cónico	Ø40	60	4,22
SIFÓN Y GRIEGA PARA RECIBIR TUBOS LISOS								
<i>"Y" TRAP WITH CONNECTION FOR SMOOTH PIPES</i>								



T-9	1½	50053			Registro Cónico	Ø70	50	6,58
SIFÓN Y GRIEGA CON CADENA								
<i>"Y" TRAP WITH CHAIN</i>								



T-10	1½	50054			Registro Cónico	1¼	60	3,72
T-10	1½	50055			1½	60	3,79	
SIFÓN Y GRIEGA CON TUERCA LOCA								
<i>"Y" TRAP WITH SLIP NUT</i>								



T-30M	1½	50064			Registro Cónico	Ø70	50	5,33
T-30M	1¼	50164			Ø70	50	5,33	
SIFÓN CURVO EXTENSIBLE								
<i>EXTENSIBLE CURVED TRAP</i>								



REF.	SALIDA	CÓDIGO	APLICACIÓN	COTAS	ENTRADA	U/C	PVP €
REF.	OUTLET	CODE	APPLICATION	DIMENSIONS	INLET	U/Box	€/pc
T-30MC	1½	50065			 Registro Cónico Ø70	50	6,65
T-30MC	1¼	50163	 			50	6,65

SIFÓN CURVO EXTENSIBLE CON CADENA
 EXTENSIBLE CURVED TRAP WITH CHAIN



T-30	1½	50057	 		 Registro Cónico Ø70	40	5,47
------	----	-------	----------	--	-----------------------------------	----	------

SIFÓN CURVO EXTENSIBLE
 EXTENSIBLE CURVED TRAP



T-30C	1½	50058	 		 Registro Cónico Ø70	40	6,71
-------	----	-------	----------	--	-----------------------------------	----	------

SIFÓN CURVO EXTENSIBLE CON CADENA
 EXTENSIBLE CURVED TRAP WITH CHAIN



T-30E	1½	50088			 Registro Cónico Ø115	60	8,25
-------	----	-------	--	--	------------------------------------	----	------

SIFÓN CURVO EXTENSIBLE
 EXTENSIBLE CURVED TRAP



T-31M	1½	50066			 Registro Cónico	60	3,58
T-31M	1¼	50166	 			 1¼	60

SIFÓN CURVO EXTENSIBLE CON TUERCA LOCA
 EXTENSIBLE CURVED TRAP WITH SLIP NUT



T-31	1½	50059	 		 Registro Cónico	50	3,55
------	----	-------	----------	--	----------------------------	----	------

SIFÓN CURVO EXTENSIBLE CON TUERCA LOCA
 EXTENSIBLE CURVED TRAP WITH SLIP NUT



REF.	SALIDA	CÓDIGO	APLICACIÓN	COTAS	ENTRADA	U/C	PVP €
REF.	OUTLET	CODE	APPLICATION	DIMENSIONS	INLET	U/Box	€/pc
T-31T	1½	50060				35	4,67
Registro Cónico							
SIFÓN CURVO EXTENSIBLE CON TOMA DE LAVADORA							
<i>EXTENSIBLE CURVED TRAP WITH CONNECTION FOR WASHING MACHINE</i>							



T-31TD	1½	50093				35	5,62
Registro Cónico							
SIFÓN CURVO EXTENSIBLE CON DOBLE TOMA DE LAVADORA							
<i>EXTENSIBLE CURVED TRAP WITH DOUBLE CONNECTION FOR WASHING MACHINE</i>							



T-31L	1½	50071				60	3,00
T-31L	1½	50072				50	3,51
Registro Cónico							
SIFÓN CURVO PARA RECIBIR TUBOS LISOS							
<i>CURVED TRAP WITH CONNECTION FOR SMOOTH PIPES</i>							



T-34	1½	50063				35	4,58
Registro Cónico							
SIFÓN CURVO CON TOMA DE LAVADORA							
<i>CURVED TRAP WITH CONNECTION FOR WASHING MACHINE</i>							



T-79	Ø40	50541			Ø50	35	15,84
Registro Cónico							
DESAGÜES URINARIO							
<i>URINAL WASTE OUTLET</i>							



T-79-C	Ø40	50542			Ø50	35	15,54
Registro Cónico							
DESAGÜES URINARIO ACODADO CON PLAFÓN							
<i>URINAL WASTE OUTLET WITH COVER, ELBOW</i>							



REF.	SALIDA	CÓDIGO	APLICACIÓN	COTAS	ENTRADA	U/C	PVP €
REF.	OUTLET	CODE	APPLICATION	DIMENSIONS	INLET	U/Box	€/pc
T-31S	1½	50070			1½ 1¼	25	5,95
SIFÓN CURVO DESPLAZADO							
TRAP SIPHON SHIFTED							

Sifones con Alargadera Flexible / Orientable



REF.	SALIDA	CÓDIGO	APLICACIÓN	COTAS	ENTRADA	U/C	PVP €
REF.	OUTLET	CODE	APPLICATION	DIMENSIONS	INLET	U/Box	€/pc
T-32 F	Ø40	50061			 Ø70	50	7,38
SIFÓN CURVO SALIDA FLEXIBLE Y ENCOLABLE A P.V.C.							
CURVED TRAP WITH FLEXIBLE OUTLET, TO BE GLUED TO PVC							



REF.	SALIDA	CÓDIGO	APLICACIÓN	COTAS	ENTRADA	U/C	PVP €
REF.	OUTLET	CODE	APPLICATION	DIMENSIONS	INLET	U/Box	€/pc
T-33 F	Ø40	50062			 1½	60	5,90
SIFÓN CURVO SALIDA FLEXIBLE Y ENCOLABLE A P.V.C.							
CURVED TRAP WITH FLEXIBLE OUTLET, TO BE GLUED TO PVC							

Sifones Flexibles / Goma



REF.	SALIDA	CÓDIGO	APLICACIÓN	COTAS	ENTRADA	U/C	PVP €
REF.	OUTLET	CODE	APPLICATION	DIMENSIONS	INLET	U/Box	€/pc
T-15	Ø35	50114			Ø35	20	5,41
T-15	Ø40	50115			Ø40	20	5,41
SIFÓN FLEXIBLE SALIDA HORIZONTAL							
FLEXIBLE HORIZONTAL SIFON							



REF.	SALIDA	CÓDIGO	APLICACIÓN	COTAS	ENTRADA	U/C	PVP €
REF.	OUTLET	CODE	APPLICATION	DIMENSIONS	INLET	U/Box	€/pc
T-16	Ø35	50116			Ø35	20	5,95
T-16	Ø40	50117			Ø40	20	5,95
SIFÓN FLEXIBLE SALIDA VERTICAL							
FLEXIBLE HORIZONTAL SIFON							

Adaptaciones Sifones Flexibles / Goma



REF.	SALIDA	CÓDIGO	APLICACIÓN	COTAS	ENTRADA	U/C	PVP €
REF.	OUTLET	CODE	APPLICATION	DIMENSIONS	INLET	U/Box	€/pc
T-17	Ø35	50118		PARA T-15 y T-16	Ø70	20	6,49
T-17	Ø40	50119			Ø70	20	6,49

VÁLVULA LAVABO/BIDE Ø70 PARA SIFÓN FLEXIBLE
FLEXIBLE SIPHON VALVE



T-18	Ø35	50120		PARA T-15 y T-16	1¼	20	2,71
T-18	Ø40	50122			1½	20	2,71

RACORD PARA SIFÓN FLEXIBLE
FLEXIBLE SIPHON RACORD

Manguito Extensible Dual Encolable



REF.	SALIDA	CÓDIGO	APLICACIÓN	COTAS	ENTRADA	U/C	PVP €
REF.	OUTLET	CODE	APPLICATION	DIMENSIONS	INLET	U/Box	€/pc
T-39M	Ø32 Ø40	50089		Ø40 - Ø32 Ø32 - Ø40 MIN.350-900 MAX.	Ø32 Ø40	30	3,62
T-39M	Ø40 Ø50	50090		Ø50 - Ø40 Ø40 - Ø50 MIN.350-900 MAX.	Ø40 Ø50	30	3,62

MANGUITO EXTENSIBLE DUAL, **ENCOLABLE**
FLEXIBLE DUAL SLEEVE, TO BE GLUED

Manguitos PVC Flexibles Encolable





REF.	SALIDA	CÓDIGO	APLICACIÓN	COTAS	ENTRADA	U/C	PVP €
REF.	OUTLET	CODE	APPLICATION	DIMENSIONS	INLET	U/Box	€/pc
T-225	Ø32	50132		LONGITUD 240mm	Ø32	20	4,89
T-225	Ø40	50140		LONGITUD 270mm	Ø40	15	5,15
T-225	Ø50	50150		LONGITUD 300mm	Ø50	10	6,70

MANGUITO DUAL PVC FLEXIBLE
DUAL FLEXIBLE PVC HOSE

T-39D DUAL 3 en 1 SIEMPRE TUERCA LOCA PATENTADO

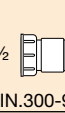

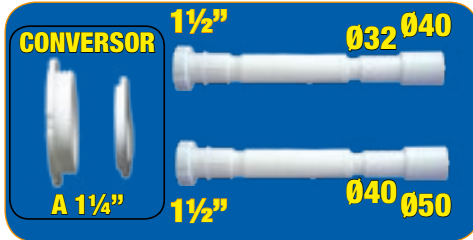

REF.	SALIDA	CÓDIGO	APLICACIÓN	COTAS	ENTRADA	U/C	PVP €
REF.	OUTLET	CODE	APPLICATION	DIMENSIONS	INLET	U/Box	€/pc
T-39D	Ø40 Ø32	50039	1 1/2"  MIN.300-900 MAX.	Ø32 PVC ENCOLABLE Ø40	1 1/2"	30	3,25
T-39D	Ø50 Ø40	50040	1 1/2"  MIN.300-900 MAX.	Ø40 PVC ENCOLABLE Ø50	1 1/2"	30	3,25



SIFÓN EXTENSIBLE DUAL CON TUERCA LOCA **PRODUCTO ENCOLABLE**
DUAL FLEXIBLE TRAP WITH SLIP NUT

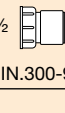

Sifones Extensibles Asiento Dual Cónico/Plano

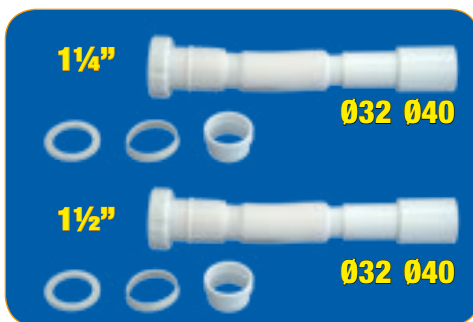

T-39	Ø32 Ø40	50076	1 1/4"  MIN.300-900 MAX.	Ø32 PVC ENCOLABLE Ø40	1 1/4"	30	2,99
T-39	Ø32 Ø40	50077	1 1/2"  MIN.300-900 MAX.	Ø32 PVC ENCOLABLE Ø40	1 1/2"	30	2,99
T-39	Ø40 Ø50	50102	1 1/2"  MIN.300-900 MAX.	Ø40 PVC ENCOLABLE Ø50	1 1/2"	30	2,99

SIFÓN EXTENSIBLE CON TUERCA LOCA, **PRODUCTO ENCOLABLE**
FLEXIBLE TRAP WITH SLIP NUT, TO BE GLUED

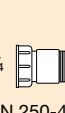

T-39C	Ø40 Ø32	50846	1 1/4"  MIN.250-450 MAX.	Ø32 PVC ENCOLABLE Ø40	1 1/4"	30	3,15
T-39C	Ø40 Ø32	50843	1 1/2"  MIN.250-450 MAX.	Ø32 PVC ENCOLABLE Ø40	1 1/2"	30	3,15

SIFÓN EXTENSIBLE CORTO CON TUERCA LOCA **PRODUCTO ENCOLABLE**
FLEXIBLE TRAP WITH SLIP NUT

Sifón Flexible Acortable de 0 a 450mm



T-35	1 1/2"	50069		1 1/2" DUAL Ø INTERIOR 40 MAX. EXTENDIDO 450 mm	1 1/4" 1 1/2"	25	5,50
------	--------	-------	---	---	------------------	----	------

SIFÓN FLEXIBLE SALIDA A P.V.C. ACORTABLE DE 0 A 450 mm
FLEXIBLE TRAP WITH OUTLET TO PVC, EXPANDABLE UP TO 450 mm



Sifones y válvulas fregaderos

Accesorios

Sink traps and valves
Accessories



Un verdadero sistema de ahorro de espacio

Sink Traps

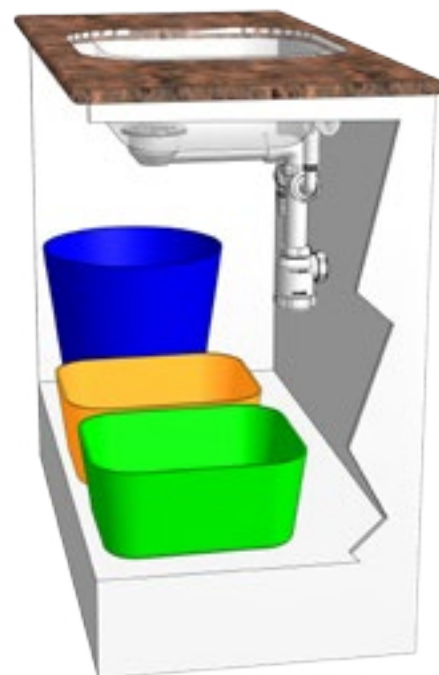

REF.	MODELO	CÓDIGO	MEDIDA	ENTRADA	U/C	PVP €
REF.	MODEL	CODE	DIMENSIONS	INLET	U/Box	€/pc
T-55 R		50250	230-490	1½	6	10,51
T-55		50251	230-490	Ø70	6	13,58
		50252		Ø115	6	15,76
T-55 BP		50253	230-490	Ø115	6	17,63
T-55 BM		50254	230-490	Ø115	6	18,43

KIT DESAGÜE FREGADERO AHORRO ESPACIO CON SIFÓN BOTELLA

SINK DRAIN SPACE SAVING KIT WITH BOTTLE TRAP



T-57 R		50470	230-490	1½	6	11,04
T-57		50471	230-490	Ø70	6	14,26
		50472		Ø115	6	16,55
T-57 BP		50473	230-490	Ø115	6	18,51
T-57 BM		50474	230-490	Ø115	6	19,35

KIT DESAGÜE FREGADERO AHORRO ESPACIO CON SIFÓN CURVO

SINK DRAIN SPACE SAVING KIT WITH CURVED TRAP

Una solución completa desde el fregadero a la pared

Sink Traps

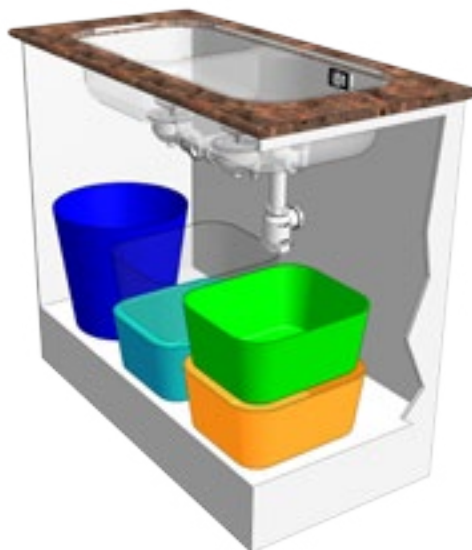

MODELO	CÓDIGO	CÓDIGO	Ø	U/C	PVP €
MODEL	CODE	CODE	Ø	U/Box	€/pc
	T-52 R	50490	1½	6	3,95
	T-52	50491	70	6	6,06
	T-52	50492	115	6	7,01
	T-52 BP	50493	115	6	8,19
	T-52 BM	50494	115	6	8,66

RECAMBIOS BRAZOS AHORRO ESPACIO
SPACE SAVING SPARE PARTS



REF.	MODELO	CÓDIGO	MEDIDA	ENTRADA	U/C	PVP €
REF.	MODEL	CODE	DIMENSIONS	INLET	U/Box	€/pc
T-56 R		50255	230-490	1½	6	13,06
T-56		50256	230-490	Ø70	6	18,74
		50257		Ø115	6	23,22
T-56 BP		50258	230-490	Ø115	6	27,16
T-56 BM		50259	230-490	Ø115	6	28,75

KIT DESAGÜE FREGADERO AHORRO ESPACIO CON SIFÓN BOTELLA

SINK DRAIN SPACE SAVING KIT WITH BOTTLE TRAP



NOVEDAD

T-58 R		50475	230-490	1½	6	13,71
T-58		50476	230-490	Ø70	6	19,68
		50477		Ø115	6	24,38
T-58 BP		50478	230-490	Ø115	6	28,52
T-58 BM		50479	230-490	Ø115	6	30,19

KIT DESAGÜE FREGADERO AHORRO ESPACIO CON SIFÓN CURVO

SINK DRAIN SPACE SAVING KIT WITH CURVED TRAP



REF.	SALIDA	CÓDIGO	APLICACIÓN	ALTURA	ENTRADA	U/C	PVP €
REF.	OUTLET	CODE	APPLICATION	HEIGHT	INLET	U/Box	€/pc
T-44	1½	50200		490		25	12,27
T-44	1½	50201		230			

SIFÓN DOBLE CON VÁLVULAS EXTENSIBLES
DOUBLE TRAP WITH EXTENSIBLE VALVES



T-44 E	1½	50202		490 230		25	16,70
--------	----	-------	--	------------	--	----	-------

SIFÓN DOBLE CON VÁLVULAS EXTENSIBLES
DOUBLE TRAP WITH EXTENSIBLE VALVES



T-44 ER	1½	50214		490 230		20	18,63
T-44 ER	1½	50228				20	19,60

SIFÓN DOBLE CON VÁLVULAS EXTENSIBLES Y REBOSADERO
DOUBLE TRAP WITH EXTENSIBLE VALVES AND OVERFLOW



T-45	1½	50205		490 230		30	8,77
------	----	-------	--	------------	--	----	------

SIFÓN DOBLE CON RACORD EXTENSIBLE
DOUBLE TRAP WITH EXTENSIBLE CONNECTION



T-45 L	1½	50206		490 230		40	8,77
--------	----	-------	--	------------	--	----	------

SIFÓN DOBLE CON TUERCA LOCA
DOUBLE TRAP WITH SLIP NUT



T-46	1½	50210		490 230		25	13,08
T-46	1½	50211					

SIFÓN DOBLE CON VÁLVULAS EXTENSIBLES
DOUBLE TRAP WITH EXTENSIBLE VALVES



REF.	SALIDA	CÓDIGO	APLICACIÓN	ALTURA	ENTRADA	U/C	PVP €
REF.	OUTLET	CODE	APPLICATION	HEIGHT	INLET	U/Box	€/pc
T-46 E	1½	50212		Registro Cónico 490 230	 Ø115	25	16,08
SIFÓN DOBLE CON VÁLVULAS EXTENSIBLES <i>DOUBLE TRAP WITH EXTENSIBLE VALVES</i>							



T-47	1½	50215		Registro Cónico 490 230	 1½	30	8,69
SIFÓN DOBLE EXTENSIBLE CON RACORD <i>EXTENSIBLE DOUBLE TRAP WITH CONNECTION</i>							



T-47 L	1½	50216		Registro Cónico 490 230	 1½	40	8,77
SIFÓN DOBLE EXTENSIBLE CON TUERCA LOCA <i>EXTENSIBLE DOUBLE TRAP WITH SLIP NUT</i>							



T-49	1½	50220		Registro Cónico 600 165	 Ø70	25	13,15
T-49	1½	50221			 Ø85	25	14,22
SIFÓN DOBLE CON VÁLVULAS EXTENSIBLES <i>DOUBLE TRAP WITH EXTENSIBLE VALVES</i>							



T-49 E	1½	50222		Registro Cónico 600 165	 Ø115	25	16,26
SIFÓN DOBLE CON VÁLVULAS EXTENSIBLES <i>DOUBLE TRAP WITH EXTENSIBLE VALVES</i>							





T-50	1½	50225		Registro Cónico 600 165	 1½	30	8,74
SIFÓN DOBLE EXTENSIBLE CON RACORD <i>EXTENSIBLE DOUBLE TRAP WITH CONNECTION</i>							



Sifones fregadero con válvula cesta

Válvula fregadero cesta





REF.	SALIDA	CÓDIGO	APLICACIÓN	ALTURA	ENTRADA	U/C	PVP €
REF.	OUTLET	CODE	APPLICATION	HEIGHT	INLET	U/Box	€/pc
T-2C BP	1½	50003		135 185	 Ø115	30	9,69
SIFÓN BOTELLA CON VÁLVULA CESTA							
BOTTLE TRAP WITH BASKET VALVE							



T-2CR BP	1½	50004		135 185	 Ø115	25	11,46
-------------	----	-------	---	------------	---	----	-------

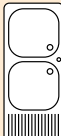

SIFÓN BOTELLA CON REBOSADERO Y VÁLVULA CESTA
BOTTLE TRAP WITH OVERFLOW AND BASKET VALVE



T-44C BP	1½	50203		490 230	 Ø115	20	21,25
-------------	----	-------	---	------------	---	----	-------

SIFÓN DOBLE CON VÁLVULA CESTA
DOUBLE TRAP WITH BASKET VALVE





T-44CR BP	1½	50204		490 230	 Ø115	20	28,46
--------------	----	-------	--	------------	---	----	-------

SIFÓN DOBLE CON REBOSADERO Y VÁLVULA CESTA
DOUBLE TRAP WITH OVERFLOW AND BASKET VALVE



Tapones cesta

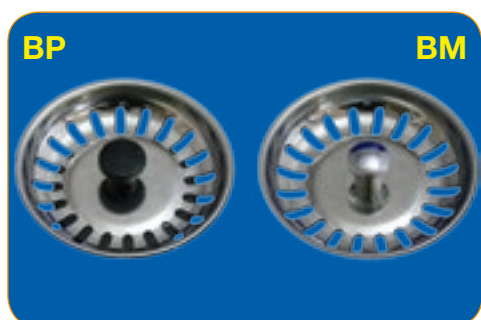

T-93	1½	50350		85	Ø115		25	3,76
T-93	1½	50351			Ø85		25	3,76

TAPÓN VÁLVULA CESTA INOX
STAINLESS STEEL BASKET VALVE PLUG



T-93 BP	1½	50358		—	Ø115		25	3,76
T-93 BM	1½	50359			Ø115		25	4,08

TAPÓN VÁLVULA CESTA INOX
STAINLESS STEEL BASKET VALVE PLUG

Deep
Series

Válvulas Fregadero Cesta

Basket sink valves

Serie honda



REF.	SALIDA	CÓDIGO	APLICACIÓN	ALTURA	ENTRADA	U/C	PVP €
REF.	OUTLET	CODE	APPLICATION	HEIGHT	INLET	U/Box	€/pc
T-72 R	1½	50343		85	Ø115	35	13,03
T-72 R	1½	50344					

VÁLVULA CESTA INOX CON REBOSADERO

STAINLESS STEEL BASKET VALVE WITH OVERFLOW



T-72	1½	50340		85	Ø115	35	12,67
T-72	1½	50341					

VÁLVULA CESTA INOX CON REBOSADERO

STAINLESS STEEL BASKET VALVE WITH OVERFLOW



T-75	1½	50342		85	BLANCO Ø115	35	10,53
T-75	1½	50372			MARRÓN Ø115		
T-75	1½	50382			TERRA FRANCE Ø115		

VÁLVULA CESTA COLOR REBOSADERO REDONDO

COLOUR BASKET VALVE WITH ROUND OVERFLOW



T-73	1½	50345		85	Ø115	55	11,55
T-73	1½	50346					

VÁLVULA CESTA INOX

STAINLESS STEEL BASKET VALVE

Low Series

Serie baja

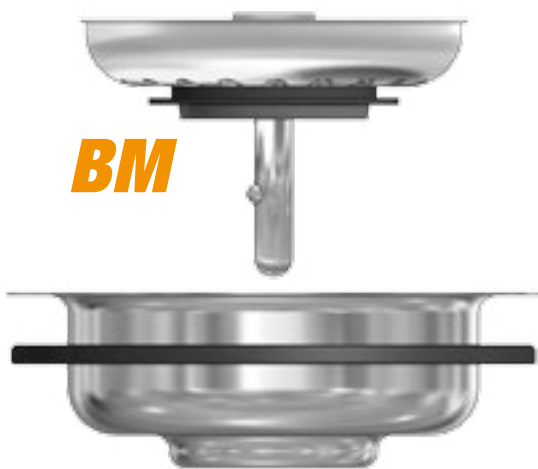

BM

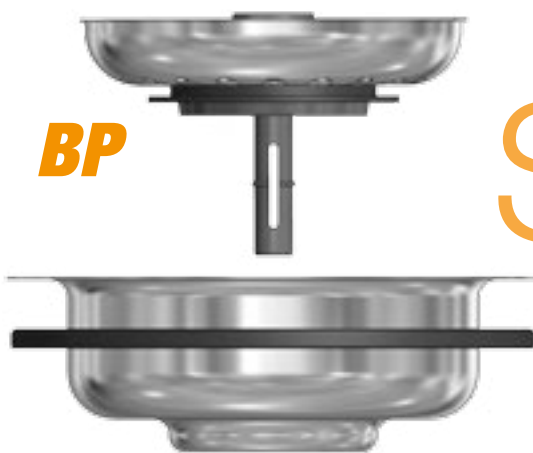

BP



REF.	SALIDA	CÓDIGO	APLICACIÓN	ALTURA	ENTRADA	U/C	PVP €
REF.	OUTLET	CODE	APPLICATION	HEIGHT	INLET	U/Box	€/pc
T-72 R BP	1½	50352		65	Ø115	35	13,03
T-72 R BM	1½	50353		65	 Ø115	35	14,07

VÁLVULA CESTA INOX REBOSADERO REDONDO
STAINLESS STEEL BASKET VALVE WITH ROUND OVERFLOW



T-72 BP	1½	50354		65	Ø115	35	12,67
T-72 BM	1½	50355		65	 Ø115	35	13,68

VÁLVULA CESTA INOX CON REBOSADERO
STAINLESS STEEL BASKET VALVE WITH OVERFLOW



T-76	1½	50347		85	BLANCO Ø115	55	8,72
T-76	1½	50377			MARRÓN Ø115	55	8,72
T-76	1½	50387			TERRA FRANCE Ø115	55	8,72

VÁLVULA CESTA COLOR
COLOUR BASKET VALVE



T-73 BP	1½	50356		65	Ø115	55	11,55
T-73 BM	1½	50357		65	 Ø115	55	11,91

VÁLVULA CESTA INOX
STAINLESS STEEL BASKET VALVE

Válvulas Fregadero y Baño



REF.	SALIDA	CÓDIGO	APLICACIÓN	ALTURA	ENTRADA	U/C	PVP €
REF.	OUTLET	CODE	APPLICATION	HEIGHT	INLET	U/Box	€/pc
T-60	1¼	50301		55	Ø70	50	3,18
T-60	1½	50300					3,24

VÁLVULA FREGADERO
SINK VALVE



T-60 G	1½	50305		55	Ø85	50	4,76

VÁLVULA FREGADERO
SINK VALVE



T-70	1½	50335		85	Ø115	60	6,39

VÁLVULA GIGANTE
BIG VALVE



T-68	1½	50325		55	Ø70	50	7,58

VÁLVULA FREGADERO CON REBOSADERO
SINK VALVE WITH OVERFLOW



T-69	1½	50330		85	Ø115	35	10,53

VÁLVULA GIGANTE CON REBOSADERO
BIG VALVE WITH OVERFLOW





T-61	1¼	50310		55	Ø70	50	4,01
T-61	1½	50315					3,96

VÁLVULA LAVABO BIDÉ
VALVE FOR SINK AND BIDET

Válvulas Ahorro Espacio 60mm





REF.	SALIDA	CÓDIGO	APLICACIÓN	ALTURA	ENTRADA	U/C	PVP €
REF.	OUTLET	CODE	APPLICATION	HEIGHT	INLET	U/Box	€/pc
T-361	1½	50461		60	 Ø70	25	4,87

VÁLVULA HORIZONTAL EXTRABAJA CON TAPÓN Y CADENA
HORIZONTAL LOW VALVE





TECNO CLICK-CLACK

T-362	1½	50462		60	 Ø70	25	10,28
-------	----	-------	--	----	---	----	-------

VÁLVULA HORIZONTAL EXTRABAJA TECNO CLICK-CLACK
HORIZONTAL LOW VALVE TECNO CLICK-CLACK





CLICK-CLACK LATÓN

T-363	1½	50463		60	 Ø70	25	20,01
-------	----	-------	---	----	---	----	-------

VÁLVULA HORIZONTAL EXTRABAJA CLICK-CLACK LATÓN
HORIZONTAL LOW VALVE CLICK-CLACK





T-361 R	1½	50464		60	 Ø70	25	8,12
---------	----	-------	--	----	---	----	------

VÁLVULA HORIZONTAL EXTRABAJA CON REBOSADERO Y CADENA
HORIZONTAL LOW VALVE WITH OVERFLOW





TECNO CLICK-CLACK

T-362 R	1½	50465		60	 Ø70	25	13,52
---------	----	-------	--	----	---	----	-------

VÁLVULA HORIZONTAL EXTRABAJA CON REBOSADERO TECNO CLICK-CLACK
HORIZONTAL LOW VALVE TECNO CLICK-CLACK WITH OVERFLOW



CLICK-CLACK LATÓN

T-363 R	1½	50466		60	 Ø70	25	23,26
---------	----	-------	--	----	---	----	-------

VÁLVULA HORIZONTAL EXTRABAJA CON REBOSADERO CLICK-CLACK LATÓN
HORIZONTAL LOW VALVE CLICK-CLACK WITH OVERFLOW

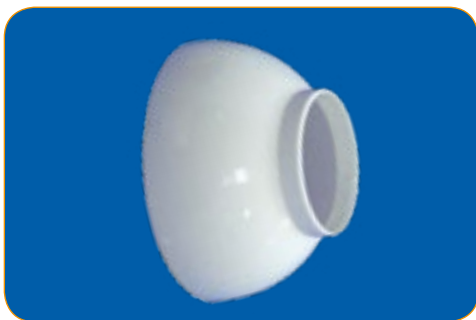

REF.	SALIDA	CÓDIGO	APLICACIÓN	ALTURA	ENTRADA	U/C	PVP €
REF.	OUTLET	CODE	APPLICATION	HEIGHT	INLET	U/Box	€/pc
T-211	Ø32	50851	CONEXIONES CONNECTIONS	—	Ø32	200	0,56
T-211	Ø40	50852		—	Ø40	200	0,56

PLAFÓN EMBELLECEDOR
WALL CAP



T-311	Ø15-25	50190	CONEXIONES CONNECTIONS	-	Ø15-25	200	0,30
T-311	Ø32-35	50191		-	Ø32-35	200	0,30
T-311	Ø40-45	50192		-	Ø40-45	200	0,30

PLAFÓN EMBELLECEDOR PLANO
WALL CAP



T-312	Ø10-25	50193	CONEXIONES CONNECTIONS	-	Ø10-25	200	0,35
-------	--------	-------	---	---	--------	-----	------

PLAFÓN EMBELLECEDOR PLANO ABIERTO (CALEFACCIÓN)
OPEN WALL CAP



T-200	1¼	50802	CONEXIONES CONNECTIONS	—	1¼	60	1,39
T-200	1½	50800		—	1½	50	1,39



CODO HEMBRA-HEMBRA
ELBOW, FEMALE-FEMALE



T-201	1¼	50806	CONEXIONES CONNECTIONS	—	1¼	60	1,39
T-201	1½	50805		—	1½	50	1,39

CODO MACHO-HEMBRA
ELBOW, MALE-FEMALE

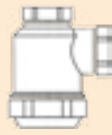

T-C	 1¼	50096		 1¼ - Ø32	 1¼	10	1,44
-----	--	-------	--	--	--	----	------

CONVERTIDOR SIFONES SALIDA HORIZONTAL A INCLINADA
TRAP CONVERTER, FROM HORIZONTAL TO BENDED OUTLET



REF.	SALIDA	CÓDIGO	APLICACIÓN	ALTURA	ENTRADA	U/C	PVP €
REF.	OUTLET	CODE	APPLICATION	HEIGHT	INLET	U/Box	€/pc
T-206	1¼	50831	CONEXIONES CONNECTIONS	65	1¼	80	1,27
T-206	1½	50830		65	1½	60	1,39

MANGUITO HEMBRA-HEMBRA
CONNECTOR, FEMALE-FEMALE



T-203	1½	50815	CONEXIONES CONNECTIONS	155	1½	40	1,76
-------	----	-------	---	-----	----	----	------

ALARGADERA HEMBRA-HEMBRA
EXTENSION, FEMALE-FEMALE



T-202	Ø40	50810	CONEXIONES CONNECTIONS	190	1½	40	1,33
-------	-----	-------	---	-----	----	----	------

ALARGADERA HEMBRA
EXTENSION, FEMALE



T-205	Ø40	50825	CONEXIONES CONNECTIONS	190	1½	30	1,71
-------	-----	-------	---	-----	----	----	------

ALARGADERA HEMBRA-HEMBRA CON PLAFÓN
EXTENSION WITH WALL CAP, FEMALE-FEMALE



T-245	1¼-32	50245	CONEXIONES CONNECTIONS	80	1¼	20	3,50
T-245	1½-40	50246		85	1½	20	3,75

VÁLVULA AIREACIÓN INTERCALABLE
AIR SYSTEM



Sistemas de Aireación

- JUNTA TÓRICA
- NO SE DEFORMA
- CIERRE POR GRAVEDAD

PATENTADO



REF.	SALIDA	CÓDIGO	APLICACIÓN	ALTURA	ENTRADA	U/C	PVP €
REF.	OUTLET	CODE	APPLICATION	HEIGHT	INLET	U/Box	€/pc
T-207	Ø32	50835	CONEXIONES CONNECTIONS	100	1¼	70	1,10
T-207	Ø40	50836		100	1½	50	1,12
T-207VA	Ø40	50837		100	1¼	60	1,15

RACORD CON TUERCA LOCA

CONNECTOR WITH SLIP NUT



T-208	Ø32	50839	CONEXIONES CONNECTIONS	100	Ø70	40	3,87
T-208	Ø40	50840		100		40	3,87

PROLONGADOR CON TAPÓN Y CADENA

EXTENSION WITH PLUG AND CHAIN



T-212	1½	50860	CONEXIONES CONNECTIONS	—	Ø25	S/P	3,58
-------	----	-------	---	---	-----	-----	------

REBOSADERO PARA FREGADEROS

SINK OVERFLOW

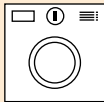

T-213	Ø40	50861		100	1½	50	2,47
-------	-----	-------	--	-----	----	----	------

CONEXIÓN CON TOMA LAVADORA

CONNECTION WITH WASHING MACHINE INLET



T-214	Ø40	50862		110	1½	50	2,17
-------	-----	-------	--	-----	----	----	------

CONEXIÓN CON TOMA LAVADORA

CONNECTION WITH WASHING MACHINE INLET



T-218	Ø40	50803		110	1½	30	2,62
-------	-----	-------	--	-----	----	----	------

CONEXIÓN CON TOMA LAVADORA DOBLE

CONNECTION WITH DOUBLE WASHING MACHINE INLET



REF.	SALIDA	CÓDIGO	APLICACIÓN	ALTURA	ENTRADA	U/C	PVP €
REF.	OUTLET	CODE	APPLICATION	HEIGHT	INLET	U/Box	€/pc
CODO AHORRO ESPACIO							
T-201B	Ø40	50363	VÁLVULAS	55	1½ 1¼	50	2,09
CODO AHORRO ESPACIO							
<i>SPACE SAVING ELBOW</i>							



T-215	Ø40	50863		25	3,21		
ALARGADERA FLEXIBLE CON SALIDA PVC							
<i>FLEXIBLE EXTENSION WITH PVC OUTLET</i>							



T-222	—	50811	REGISTRO INSPECTION	—		50	5,54
BOTE REGISTRO LLAVE CALEFACCIÓN							
<i>INSPECTION TRAP FOR HEATING SYSTEM</i>							



T-221-A	STOP	50808	TAPÓN AZUL BLUE PLUG	—	½	50	0,73
T-221-R	STOP	50809	TAPÓN ROJO RED PLUG	—	½	50	0,73
TAPÓN PARA ALICATADO CON JUNTA TÓRICA							
<i>PLUG FOR TILING WITH O-RING</i>							



T-204	Ø40	50820	CONEXIONES CONNECTIONS	250	Ø40	S/P	1,46
T-204	Ø32	50821			Ø32	S/P	1,46
ALARGADERA PVC							
<i>PVC EXTENSION</i>							

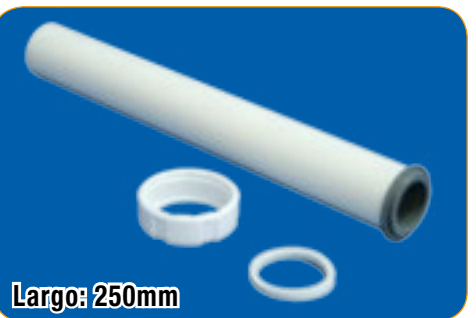

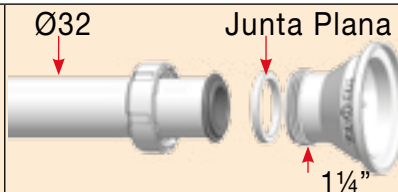
T-204C	1¼	50823		S/P	2,26		
ALARGADERA PVC Ø32 PARA RECIBIR VÁLVULAS CLICK-CLACK							
<i>PVC EXTENSION Ø32 FOR CLICK-CLACK VALVES</i>							

Largo: 250mm

Tecnoflex

Conexiones PVC flexibles



Encolable

REF.	SALIDA	CÓDIGO	APLICACIÓN	ALTURA	ENTRADA	U/C	PVP €
REF.	OUTLET	CODE	APPLICATION	HEIGHT	INLET	U/Box	€/pc
T-225	Ø32	50132		LONGITUD 240mm	Ø32	20	4,89

MANGUITO DUAL PVC FLEXIBLE Ø32
DUAL FLEXIBLE PVC HOSE



Encolable

T-225	Ø40	50140		LONGITUD 270mm	Ø40	15	5,15
-------	-----	-------	--	-------------------	-----	----	------

MANGUITO DUAL PVC FLEXIBLE Ø40
DUAL FLEXIBLE PVC HOSE



Encolable

T-225	Ø50	50150		LONGITUD 300mm	Ø50	10	6,70
-------	-----	-------	--	-------------------	-----	----	------

MANGUITO DUAL PVC FLEXIBLE Ø50
DUAL FLEXIBLE PVC HOSE

Conexiones PVC Mixtas



REF.	SALIDA	CÓDIGO	GRÁFICA	U/C	PVP €
REF.	OUTLET	CODE		U/Box	€/pc
T-209-H	Ø40	50841		75	1,38

CONVERSION EXTERIOR DE TUBO PVC A TUERCA LOCA
EXTERNAL CONVERTER, FROM PVC PIPE TO SLIP NUT



T-209-H	Ø40	50842		75	1,38
---------	-----	-------	--	----	------

CONVERSION EXTERIOR DE TUBO PVC A TUERCA LOCA
EXTERNAL CONVERTER, FROM PVC PIPE TO SLIP NUT



REF.	SALIDA	CÓDIGO	GRÁFICA	U/C	PVP €
REF.	OUTLET	CODE		U/Box	€/pc
T-209-M	Ø40	50848	<p>Junta Cónica Ø40</p>	75	1,38
CONVERSOR INTERIOR DE CODO HEMBRA PVC PARA RECIBIR TUBOS LISOS <i>INTERNAL FEMALE PVC ELBOW CONVERTER FOR SMOOTH PIPES</i>					



T-209-C	Ø40	50853	<p>Junta Cónica Ø40</p> <p>Hembra</p>	100	1,66
CONVERSOR EXTERIOR DE CODO MACHO PVC PARA RECIBIR TUBOS LISOS <i>EXTERNAL MALE PVC ELBOW CONVERTER FOR SMOOTH PIPES</i>					



T-217	Ø32	50850	<p>Junta Cónica Ø40</p>	60	1,66
T-217	Ø40	50855		60	1,66
CONVERSOR INTERIOR PARA TUBO DE PVC A TUBOS LISOS <i>INTERNAL CONVERTER FOR PVC TO SMOOTH PIPES</i>					



T-230	SALIDA Ø40	50710	<p>Junta Cónica Ø40</p>	25	1,84
	ENTRADA Ø28-35			25	
MANGUITO UNIÓN TUBO METÁLICO Ø28-35 A TUBO LISO Ø40 <i>UNION SMOOTH METAL TUBE TO TUBE</i>					



T-230	SALIDA Ø40	50711	<p>Junta Cónica Ø40</p>	25	1,84
	ENTRADA Ø38-40			25	
MANGUITO UNIÓN TUBO METÁLICO Ø38-40 A TUBO LISO Ø40 <i>UNION SMOOTH METAL TUBE TO TUBE</i>					



T-231	SALIDA Ø40 ENTRADA Ø28-32	50712	<p>Ø28-32</p> <p>Ø40</p>	30	1,55
T-231	SALIDA Ø50 ENTRADA Ø28-40	50713	<p>Ø28-40</p> <p>Ø50</p>	30	1,80
MANGUITO UNIÓN TUBO METÁLICO A TUBO PVC <i>UNION METAL TUBE SLEEVE F</i>					



REF.	SALIDA	CÓDIGO	GRÁFICA	U/C	PVP €
REF.	OUTLET	CODE		U/Box	€/pc
T-232	SALIDA Ø40 ENTRADA Ø28-32	50714		30	1,55
T-232	SALIDA Ø50 ENTRADA Ø28-40	50715		20	1,80

UNIÓN TUBO METÁLICO A CODO HEMBRA
UNION METAL TUBE SLEEVE M



T-233	SALIDA Ø40 ENTRADA Ø28-32	50716		30	1,55
T-233	SALIDA Ø50 ENTRADA Ø28-40	50717		20	1,80

UNIÓN TUBO METÁLICO A CODO MACHO
UNION METAL TUBE SLEEVE M

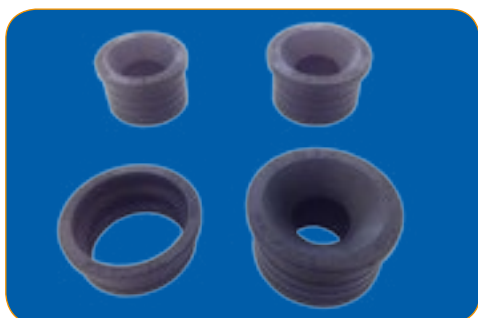

T-229	Ø28-35	50718	PARA T-230		30	1,29
	Ø38-40	50719	PARA T-230		60	1,29
	Ø28-32	50720	PARA T-231/T-232/T-233 Ø40		60	1,29
	Ø28-40	50721	PARA T-231/T-232/T-233 Ø50		30	1,29

JUNTA REPUESTO UNIÓN A TUBO METÁLICO
UNION BOARD REPLACEMENT METAL TUBE

Conexiones PVC con Toma de Lavadora



REF.	SALIDA	CÓDIGO	APLICACIÓN	ALTURA	ENTRADA	U/C	PVP €
REF.	OUTLET	CODE	APPLICATION	HEIGHT	INLET	U/Box	€/pc
T-210	Ø40	50849				60	1,48

CONEXIÓN MACHO A HEMBRA CON TOMA LAVADORA 90°
PVC MALE CONNECTION WITH WASHING MACHINE CONNECTION



T-216	Ø40	50864				60	2,24
-------	-----	-------	--	--	--	----	------



CONEXIÓN MACHO A HEMBRA CON DOBLE TOMA LAVADORA 90°
PP CONNECTION WITH WASHING MACHINE CONNECTION



REF.	SALIDA	CÓDIGO	APLICACIÓN	ALTURA	ENTRADA	U/C	PVP €
REF.	OUTLET	CODE	APPLICATION	HEIGHT	INLET	U/Box	€/pc
T-219	Ø40	50804		60	2,24		



CONEXIÓN MACHO A HEMBRA CON DOBLE TOMA LAVADORA 45°
PV DOUBLE CONNECTION WITH WASHING MACHINE



T-210I	Ø32	50748		20	1,78		
T-210I	Ø40	50749		20	1,78		



CONEXIÓN MACHO A INTERIOR TUBO CON TOMA LAVADORA 90°
PVC MALE CONNECTION WITH WASHING MACHINE CONNECTION



T-216I	Ø32	50763		20	2,54		
T-216I	Ø40	50764		20	2,54		

CONEXIÓN MACHO A INTERIOR TUBO CON DOBLE TOMA LAVADORA 90°
PVC CONNECTION WITH WASHING MACHINE CONNECTION



T-219I	Ø32	50783		20	2,54		
T-219I	Ø40	50784		20	2,54		

CONEXIÓN MACHO A INTERIOR TUBO CON DOBLE TOMA LAVADORA 45°
PVC DOUBLE CONNECTION WITH WASHING MACHINE

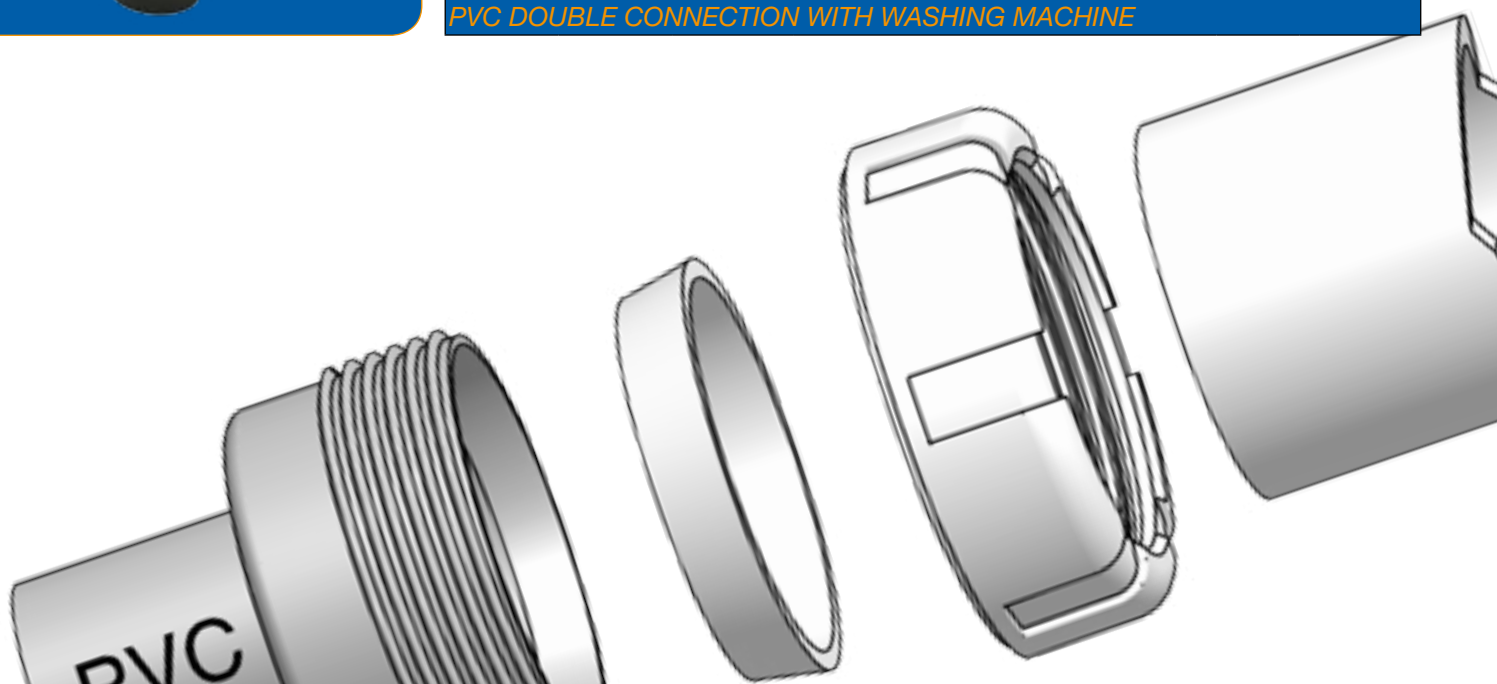



Nuevas Válvulas de Plato Ducha Obra Lineales



Desagües Baño

Bathroom waste outlets



Válvulas Plato de Ducha Obra 10 x 10

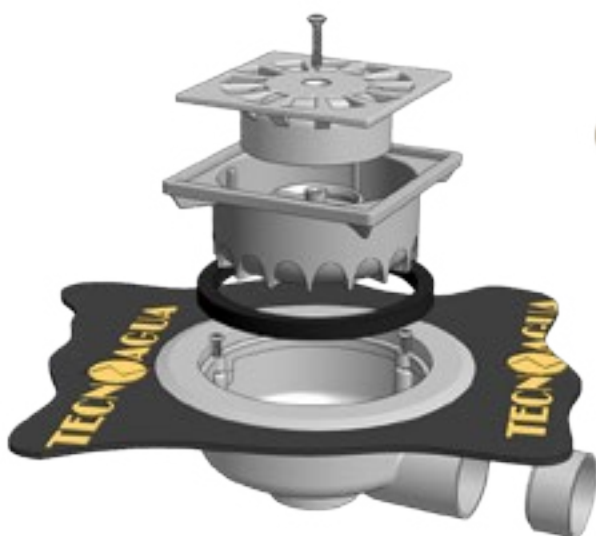

Serie PVC

REF.	SALIDA	CÓDIGO	MEDIDAS m.	ALTURA	U/C	P.V.P. €
REF.	OUTLET	CODE	DIMENSIONS m.	HEIGH	U/B	€/pc

STANDARD INOX

PLATO DUCHA OBRA

T-71	40	50536	1,8 X 1,3	65	1	59,02
T-71	40	50537	1,8 X 2	65	1	74,07

Sifónico

DIAGONAL INOX

PLATO DUCHA OBRA

T-71 D	40	50587	1,8 X 1,3	65	1	61,97
T-71 D	40	50588	1,8 X 2	65	1	77,02

Sifónico · Convertible a NO Sifónico

LUJO INOX

PLATO DUCHA OBRA

T-71 LI	40	50566	1,8 X 1,3	65	1	66,47
T-71 LI	40	50567	1,8 X 2	65	1	81,51

Sifónico

LUJO ABS

PLATO DUCHA OBRA

T-71 L	40	50543	1,8 X 1,3	65	1	59,71
T-71 L	40	50544	1,8 X 2	65	1	74,76

Sifónico

LINEAL INOX

PLATO DUCHA OBRA

T-71 N	40	50583	1,8 X 1,3	65	1	64,22
T-71 N	40	50584	1,8 X 2	65	1	79,26

Sifónico · Convertible a NO Sifónico

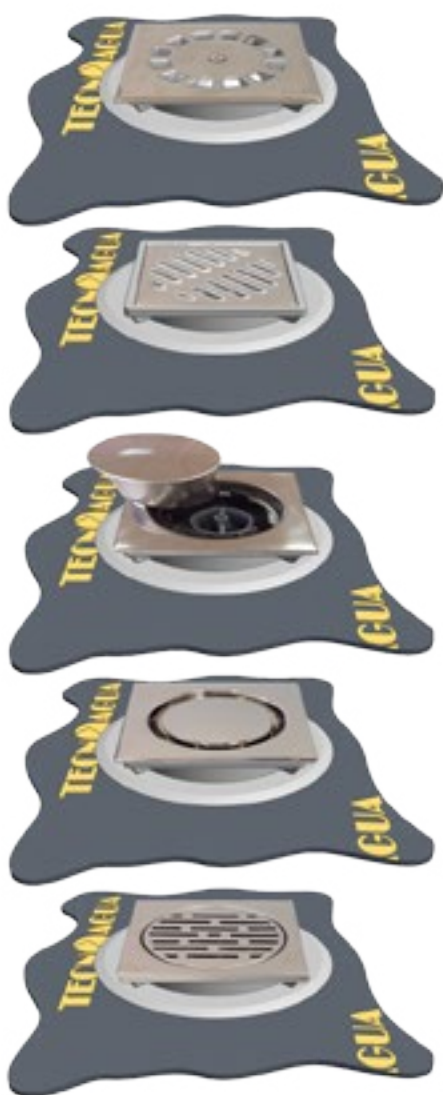

EL IMPERMEABILIZANTE LO SUMINISTRAMOS FIJADO Y SELLADO

Horizontal-Vertical Turbo System 10 x 10



Serie GEOTEXTIL

REF.	SALIDA	CÓDIGO	MEDIDAS m.	ALTURA	U/C	P.V.P. €
REF.	OUTLET	CODE	DIMENSIONS m.	HEIGH	U/B	€/pc

STANDARD INOX

PLATO DUCHA OBRA

T-71 G	40	50549	1,5 X 1,7	65	1	60,23
T-71 G	40	50550	1,5 X 2	65	1	70,42

Sifónico

DIAGONAL INOX

PLATO DUCHA OBRA

T-71 DG	40	50585	1,5 X 1,7	65	1	63,18
T-71 DG	40	50586	1,5 X 2	65	1	73,37

Sifónico · Convertible a NO Sifónico

LUJO INOX

PLATO DUCHA OBRA

T-71 LGI	40	50568	1,5 X 1,7	65	1	67,67
T-71 LGI	40	50569	1,5 X 2	65	1	77,87

Sifónico

LUJO ABS

PLATO DUCHA OBRA

T-71 LG	40	50551	1,5 X 1,7	65	1	60,92
T-71 LG	40	50552	1,5 X 2	65	1	71,12

Sifónico

LINEAL INOX

PLATO DUCHA OBRA

T-71 NG	40	50581	1,5 X 1,7	65	1	65,43
T-71 NG	40	50582	1,5 X 2	65	1	75,62

Sifónico · Convertible a NO Sifónico



EL IMPERMEABILIZANTE LO SUMINISTRAMOS FIJADO Y SELLADO

Válvulas Plato Ducha Lineales

SPACE

Geotextil 1500 x 2000

Reversible: Brillo/Satinado



Ancho 90

SPACE CURVE
T-171 SC

LARGO REJILLAS 550

CÓDIGO 50172

P.V.P. 160,00

Geotextil 1500 x 2000

Brillo

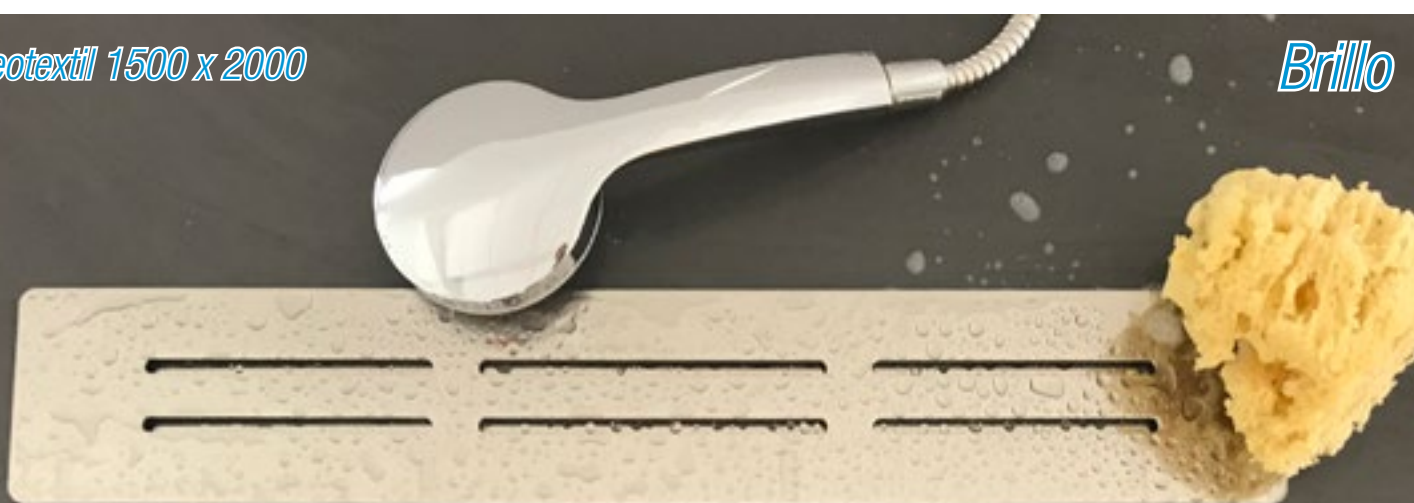

Rejilla Superpuesta con Ancho 100

SPACE LUXURY
T-171 SL

LARGO REJILLAS 550

CÓDIGO 50179

P.V.P. 180,00

Medidas Básicas

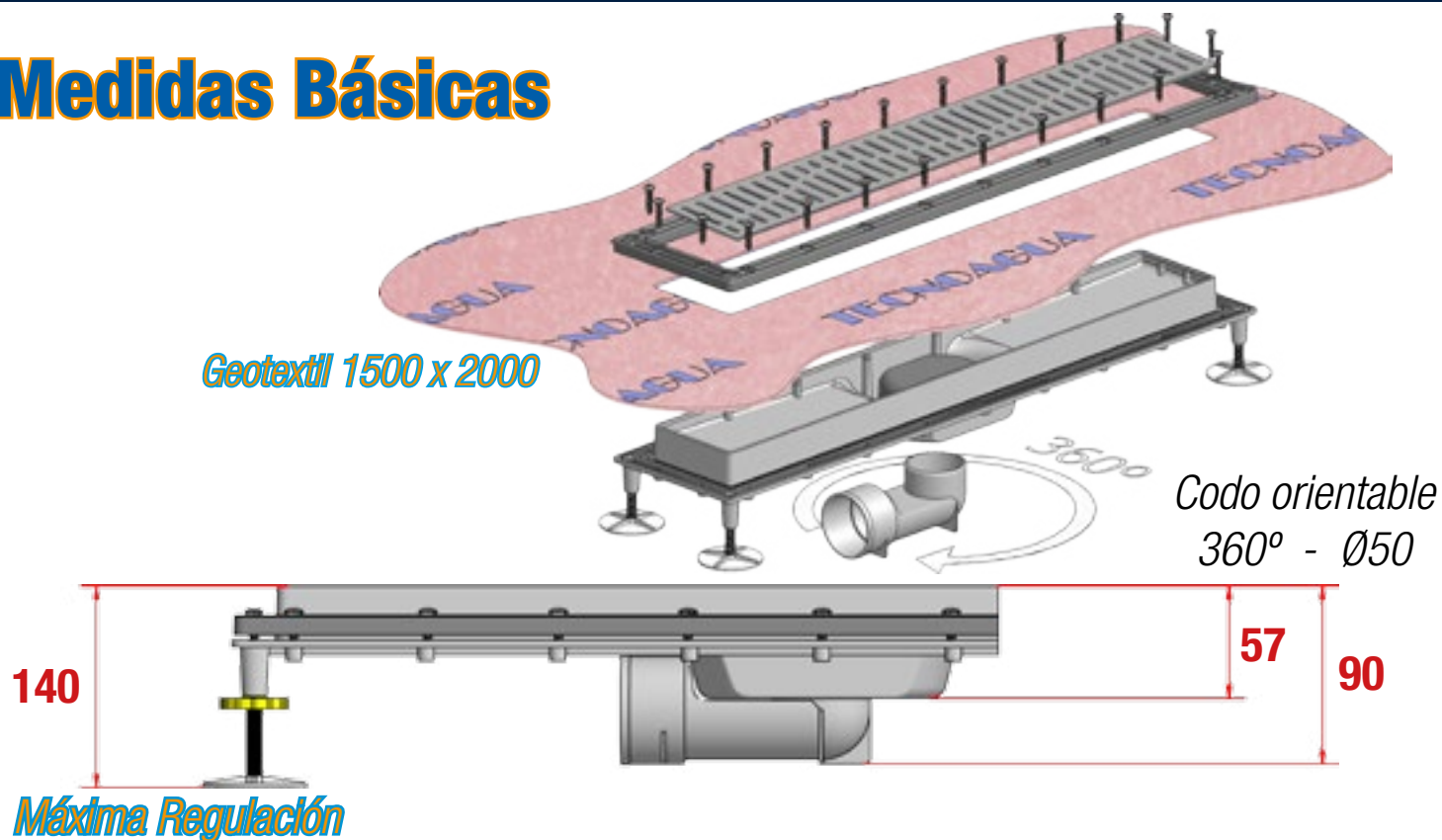

Ahorra Stock Combinándolos Elementos Suelos

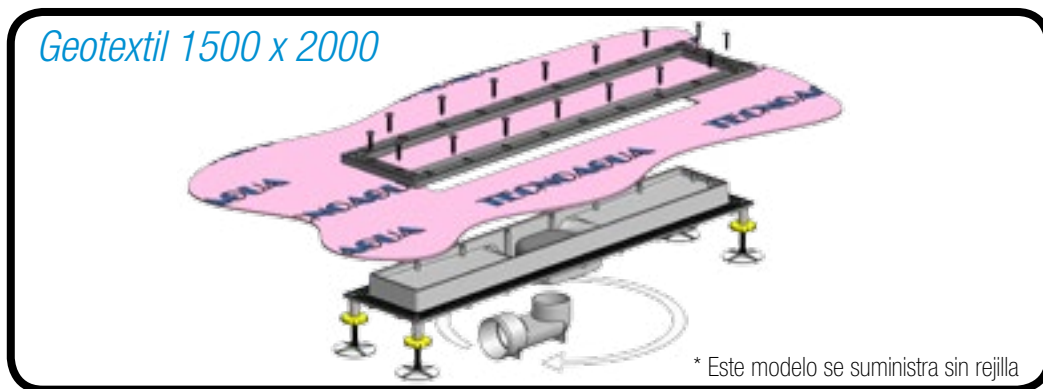

Conjunto Básico

T-171

CÓDIGO

50170

PVP

125,00



Rejilla Reversible Brillo/Satinado 90 x 550

Rejilla Curve
T-571 SC

CÓDIGO

50579

PVP

45,00



Rejilla Brillo 100 x 570

Rejilla Luxury
T-571 SL

CÓDIGO

50572

PVP

65,00

Nuevo Sistema LINE

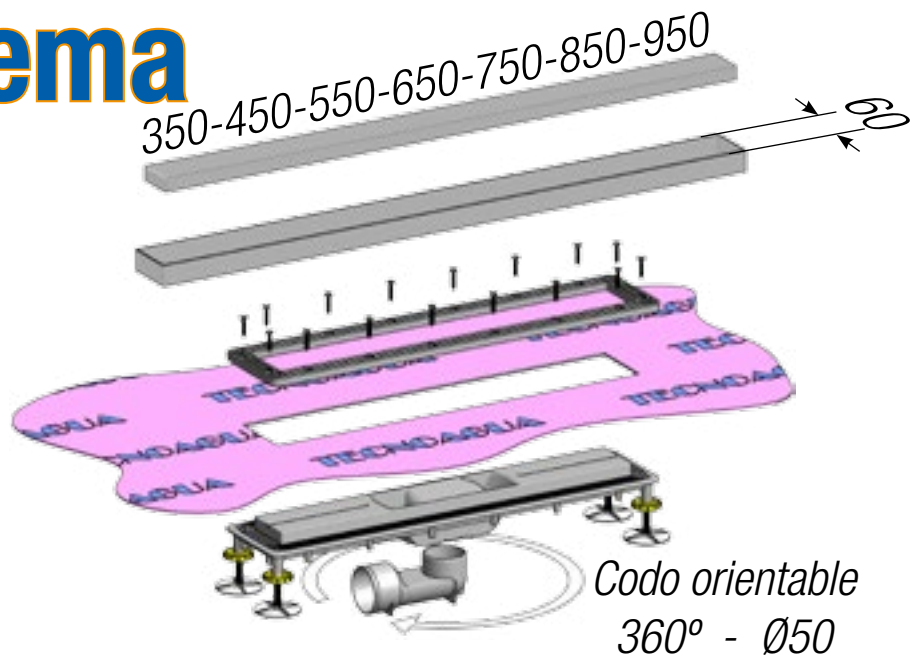

*Evacuación GRAN CAUDAL
Siempre CERCO OCULTO*

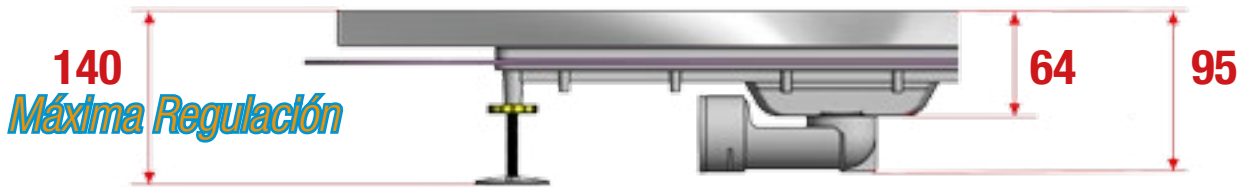

El Mismo Modelo, Dos Acabados

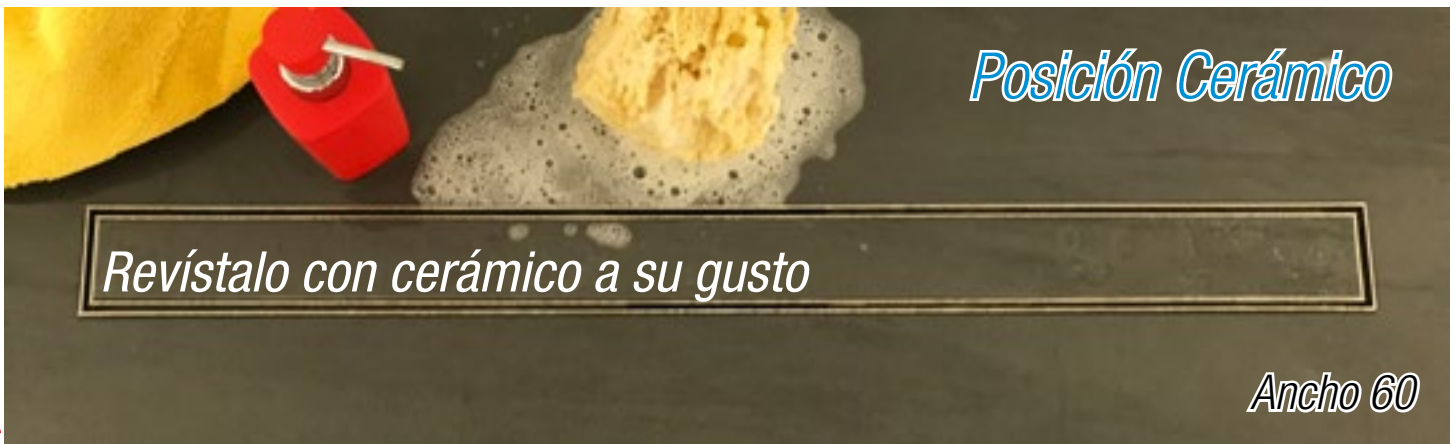

LINE DOUBLE T-181 D

LARGO REJILLAS
CÓDIGOS
PVP.

350	450	550	650	750	850	950
50283	50284	50285	50286	50287	50288	50289
173,00	183,00	193,00	203,00	213,00	223,00	233,00

Geotextil 1500 x 2000

Satinado



Ancho 60

LINE CHESS T-181 C

LARGO REJILLAS	350	450	550	650	750	850	950
CÓDIGOS	50133	50134	50135	50136	50137	50138	50139
P.V.P.	173,00	183,00	193,00	203,00	213,00	223,00	233,00

Geotextil 1500 x 2000

Satinado



Ancho 60

LINE RAIN T-181 R

LARGO REJILLAS	350	450	550	650	750	850	950
CÓDIGOS	50183	50184	50185	50186	50187	50188	50189
P.V.P.	173,00	183,00	193,00	203,00	213,00	223,00	233,00

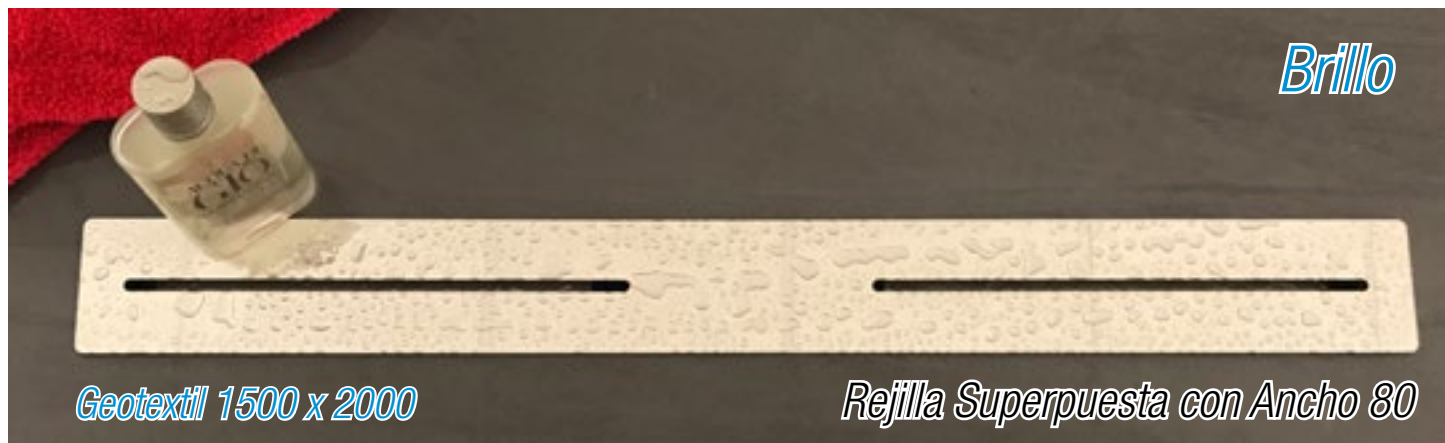

Brillo

Geotextil 1500 x 2000

Rejilla Superpuesta con Ancho 80

LINE LUXURY T-181 L

LARGO REJILLAS	350	450	550	650	750	850	950
CÓDIGOS	50123	50124	50125	50126	50127	50128	50129
P.V.P.	193,00	203,00	213,00	223,00	233,00	243,00	253,00

Ahorra Stock Combinándolos

Elementos Suelos Nuevo Sistema LINE

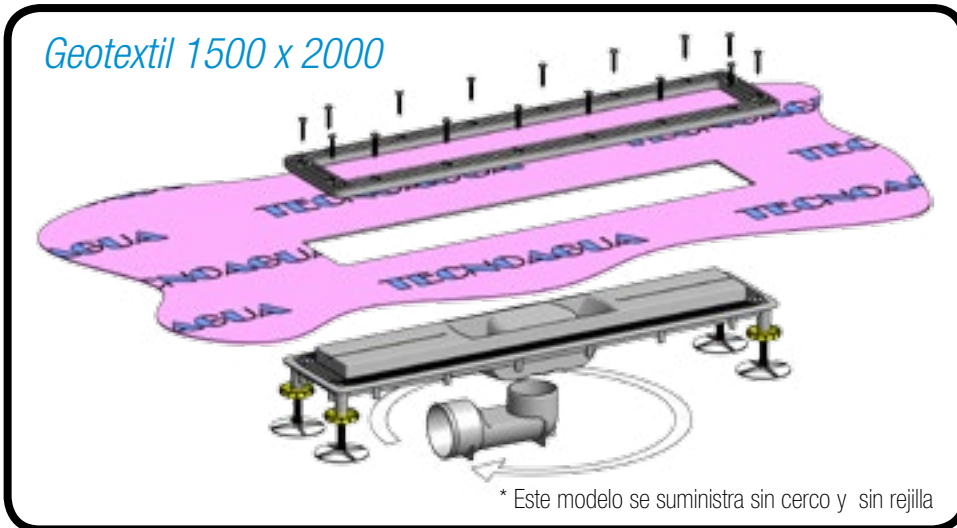

Conjunto Básico

T-181

CÓDIGO

50381

P.V.P

125,00

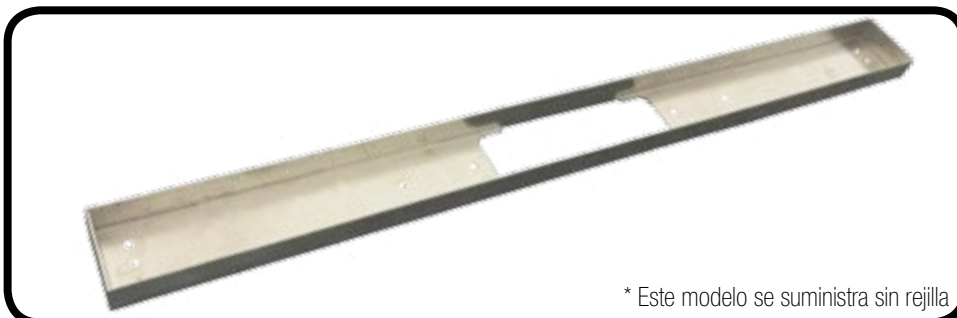

Cerco Oculto

T-1181

LARGO CERCOS	350	450	550	650	750	850	950
CÓDIGOS	55383	55384	55385	55386	55387	55388	55389
P.V.P	30,00	35,00	40,00	45,00	50,00	55,00	60,00

REJILLAS SUELTAS



Rejilla Double

T-5181 D

LARGO REJILLA	350	450	550	650	750	850	950
CÓDIGOS	55483	55484	55485	55486	55487	55488	55489
P.V.P	28,00	33,00	38,00	43,00	48,00	53,00	58,00

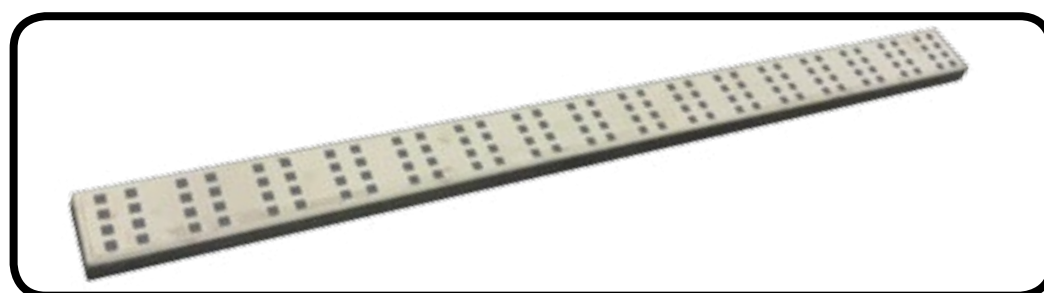

Rejilla Chess

T-5181 C

LARGO REJILLA	350	450	550	650	750	850	950
CÓDIGOS	55433	55434	55435	55436	55437	55438	55439
P.V.P	28,00	33,00	38,00	43,00	48,00	53,00	58,00

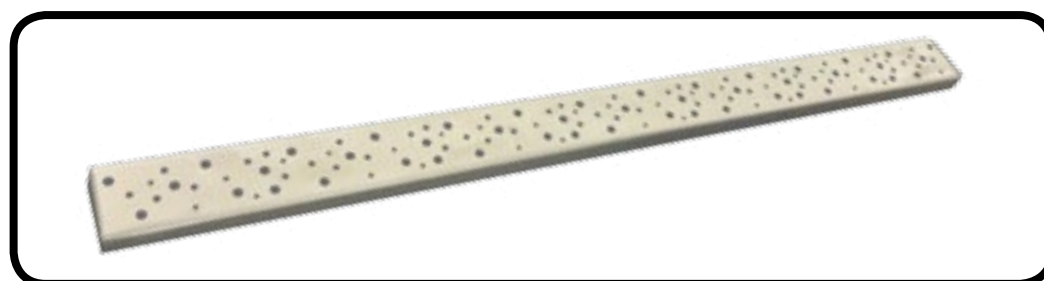

Rejilla Rain

T-5181 R

LARGO REJILLA	350	450	550	650	750	850	950
CÓDIGOS	55883	55884	55885	55886	55887	55888	55889
P.V.P	28,00	33,00	38,00	43,00	48,00	53,00	58,00

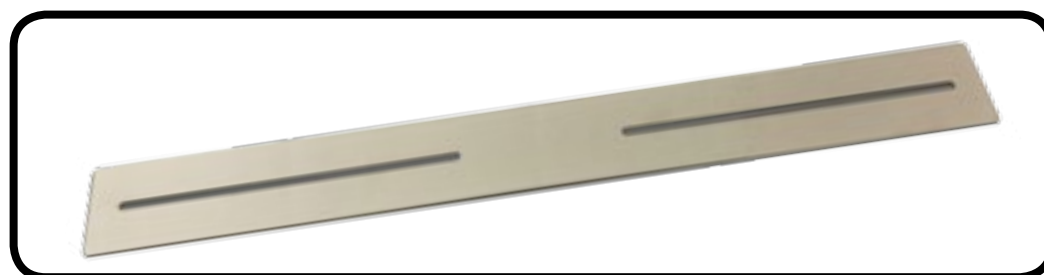

Rejilla Luxury

T-5181 L

LARGO REJILLA	350	450	550	650	750	850	950
CÓDIGOS	55423	55424	55425	55426	55427	55428	55429
P.V.P	48,00	53,00	58,00	63,00	68,00	73,00	78,00

LÁMINA GEOTEXTIL PARA IMPERMEABILIZACIONES

Se suministran en las siguientes
medidas y formatos

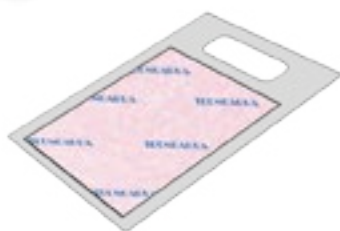
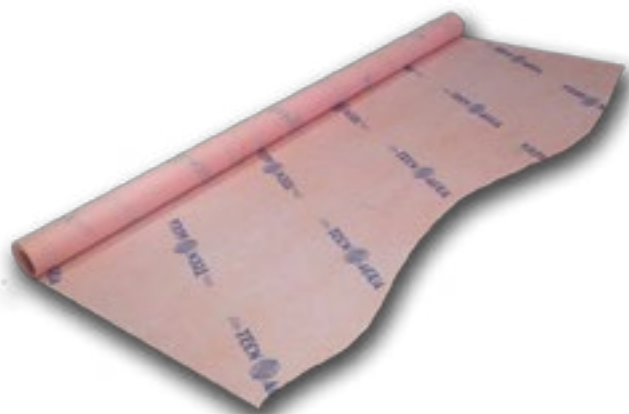

MODO	CÓDIGO	M. ANCHO	M. LARGO	M2	U/C	P.V.P. €
MODE	CODE	M. WIDTH	M. LONG	M2	U/Box	€/pc
ROLLO	50173	1,5	50	75	1	673,21
ROLLO	50174	1,5	30	45	1	428,40
ROLLO	50175	1,5	10	15	1	183,60

MODO	CÓDIGO	M. ANCHO	M. LARGO	M2	U/C	P.V.P. €
MODE	CODE	M. WIDTH	M. LONG	M2	U/Box	€/pc
BOLSA	50176	1,5	1	1,5	5	20,40
BOLSA	50177	1,5	2	3	5	40,80
BOLSA	50178	1,5	3	4,5	5	61,20

LÁMINA PVC PARA IMPERMEABILIZACIONES

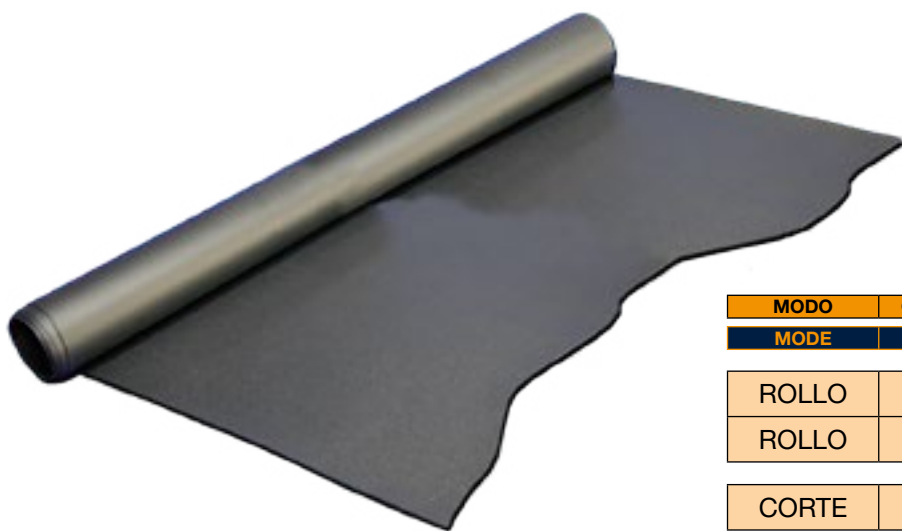

MODO	CÓDIGO	M. ANCHO	M. LARGO	M2	U/C	P.V.P. €
MODE	CODE	M. WIDTH	M. LONG	M2	U/Box	€/pc
ROLLO	50180	1,8	30	54	1	476,01
ROLLO	50181	1,8	10	18	1	204,00
CORTE	50571	1,8	2	3,6	5	44,45

Válvulas Plato de Ducha con Tornillos y Aro Metálico

Registrable



NOVEDAD

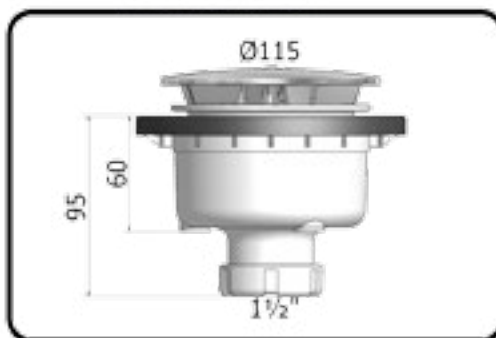

Extra bajas

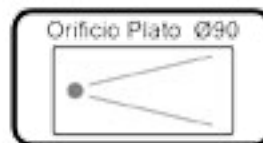

T-80 TM

Cod. 50513
Válvula Plato Ducha con Tornillos
P.V.P.: 35,36 €
U/C: 12

Registrable



NOVEDAD

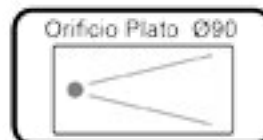
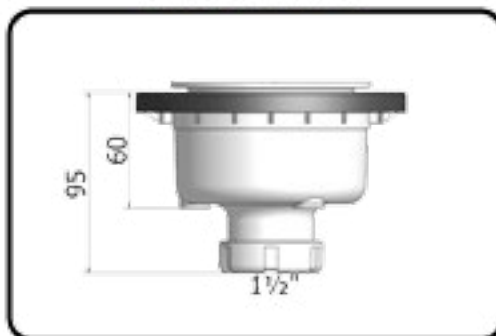

T-80 TSM
SIN EMBELLECEDOR

Cod. 50523
Válvula Plato Ducha con Tornillos
P.V.P.: 27,36 €
U/C: 40

Registrable



NOVEDAD

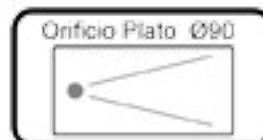
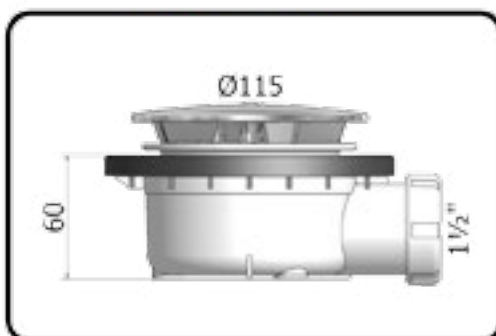

T-78 TM

Cod. 50339
Válvula Plato Ducha con Tornillos
P.V.P.: 32,42 €
U/C: 12

Registrable



NOVEDAD

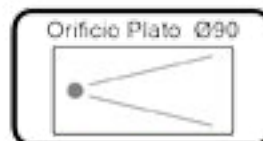
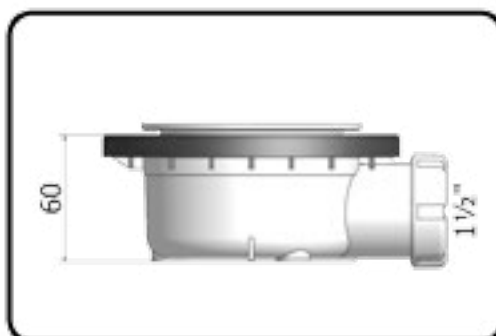

T-78 TSM
SIN EMBELLECEDOR

Cod. 50329
Válvula Plato Ducha con Tornillos
P.V.P.: 24,42 €
U/C: 50

Válvulas Plato Ducha con Tornillos Extra bajas

Registrable

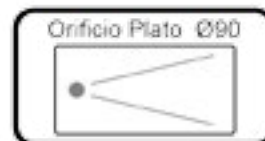
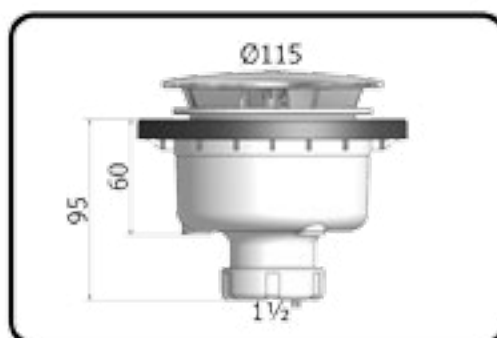

T-80 T

Cod. 50528
Válvula Plato Ducha con Tornillos
P.V.P.: 32,36 €
UIC: 12

Registrable

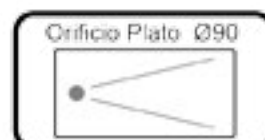
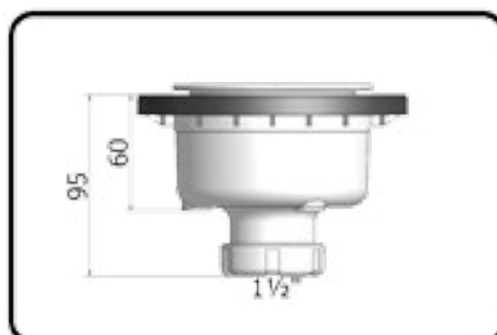

T-80 TS
SIN EMBELLECEDOR

Cod. 50529
Válvula Plato Ducha con Tornillos
P.V.P.: 24,36 €
UIC: 40

Registrable

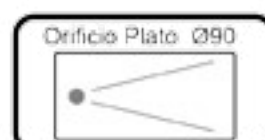
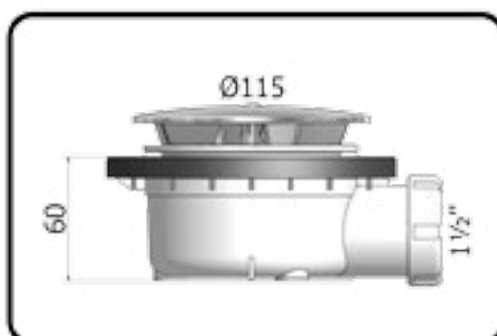

T-78 T

Cod. 50238
Válvula Plato Ducha con Tornillos
P.V.P.: 29,42 €
UIC: 12

Registrable

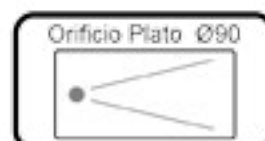
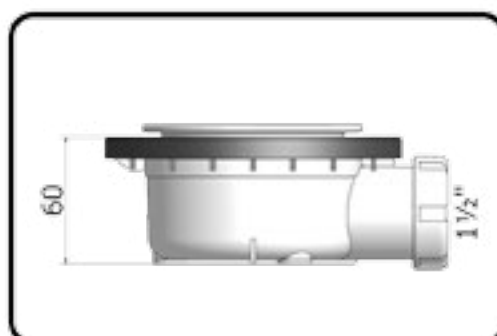

T-78 TS
SIN EMBELLECEDOR

Cod. 50328
Válvula Plato Ducha con Tornillos
P.V.P.: 21,42 €
UIC: 50

Registrable

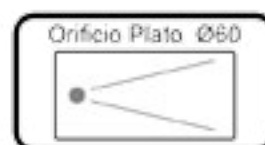

T-77 T

Cod. 50526
Válvula Plato Ducha con Tornillos
P.V.P.: 20,60 €
UIC: 15

Registrable

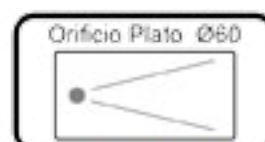

T-77 TS SIN EMBELLECEDOR

Cod. 50527
Válvula Plato Ducha con Tornillos
P.V.P.: 15,60 €
UIC: 60

Extra baja - Registrable

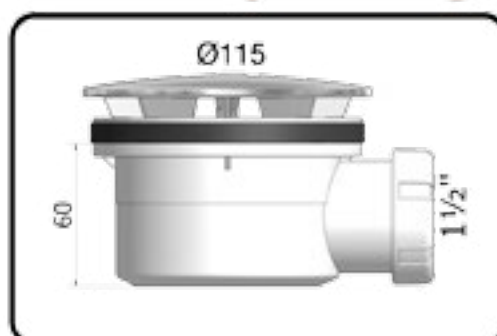

T-78 B

Cod. 50232
Válvula Plato Ducha Sifónica Extraible
P.V.P.: 26,48 €
UIC: 12

Extra baja - Registrable

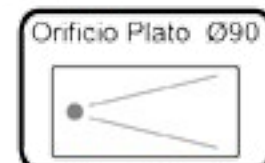
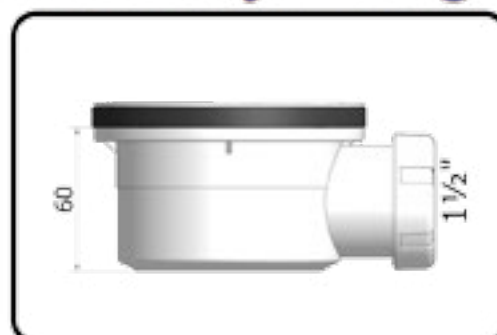

T-78 BS SIN EMBELLECEDOR

Cod. 50323
Válvula Plato Ducha Sifónica Extraible
P.V.P.: 18,48 €
UIC: 60



Extra baja - Registrable

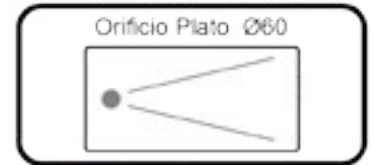
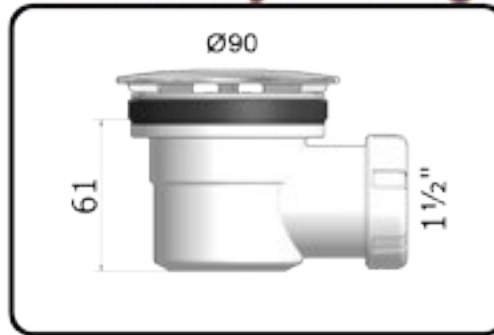

T-77

Cod. 50538
Válvula Plato Ducha Sifónica Extraible
P.V.P.: 18,54 €
UIC: 15



Registrable

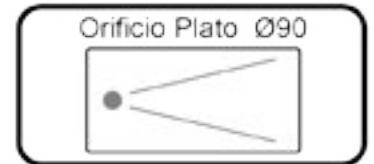

T-78

Cod. 50539
Válvula Plato Ducha Sifónica Extraible
P.V.P.: 27,80 €
UIC: 12

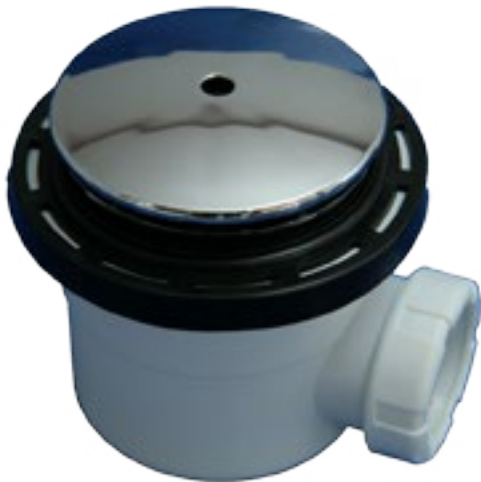

Registrable

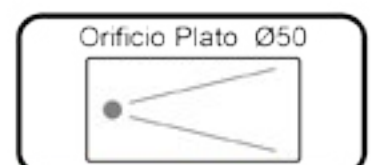
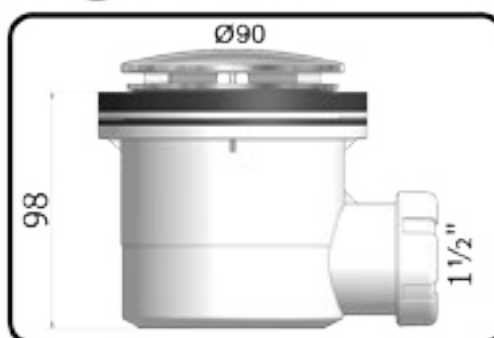

T-77 A

Cod. 50555
Válvula Plato Ducha Sifónica Extraible
P.V.P.: 15,01 €
UIC: 12



Registrable

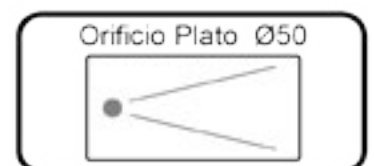

T-77 B

Cod. 50556
Válvula Plato Ducha **NO Sifónica**
P.V.P.: 14,25 €
UIC: 12



Registrable

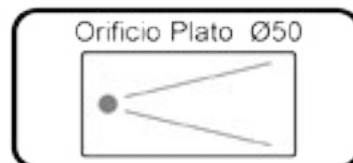

T-74 G

Cod. 50547
Válvula Plato Ducha Sifónica Extraible
P.V.P.: 15,01 €
U/C: S/P



Registrable

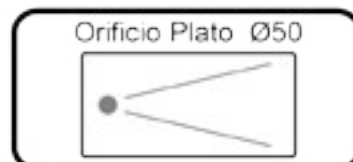
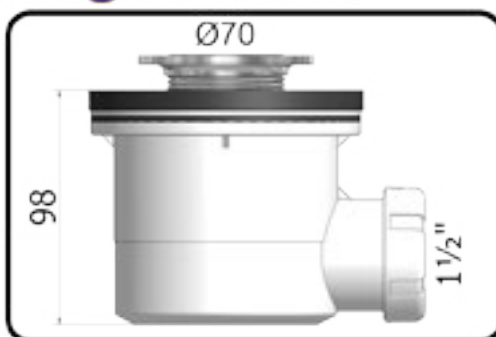

T-74 P

Cod. 50548
Válvula Plato Ducha Sifónica Extraible
P.V.P.: 14,25 €
U/C: S/P



Extra baja - Registrable

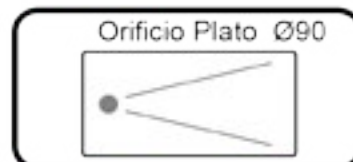
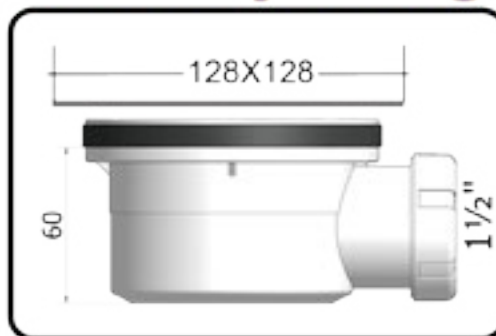

T-78 BC

Cod. 50236
Válvula Plato Ducha Sifónica Extraible
P.V.P.: 31,52 €
U/C: 12



Extra baja - Registrable

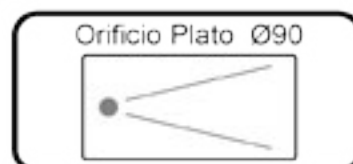
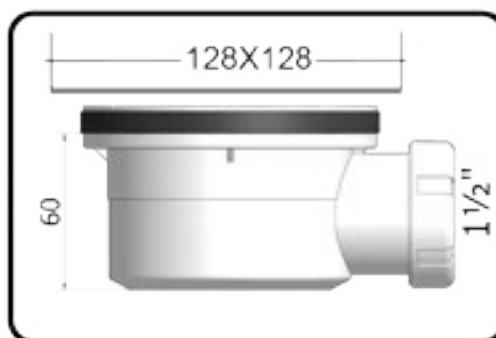

T-78 BN

Cod. 50237
Válvula Plato Ducha Sifónica Extraible
P.V.P.: 31,52 €
U/C: 12

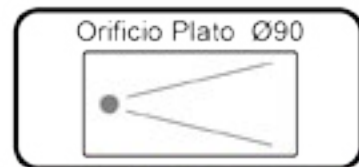

T-578 BC

Cod. 50240
Rejilla Inox Válvula Plato Ducha
P.V.P.: 12,61 €
UIC: S/P

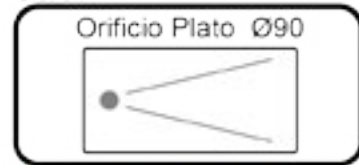

T-578 BN

Cod. 50241
Rejilla Inox Válvula Plato Ducha
P.V.P.: 12,61 €
UIC: S/P

Válvulas plato de ducha



REF.	SALIDA	CÓDIGO	APLICACIÓN	ALTURA	ENTRADA	U/C	PVP €
REF.	OUTLET	CODE	APPLICATION	HEIGHT	INLET	U/Box	€/pc
T-67 PVC	1½	50320		90	Ø85	100	4,08
T-67 PVC	1½	50535		110	Ø115	50	7,15

VÁLVULA PLATO DE DUCHA ENCOLAR **ASIENTO CÓNICO - PLANO**
SHOWER TRAY VALVE, TO GLUE **CONICAL SEAT - FLAT**



T-81	1½	50533		60	Ø85	60	3,57
T-81	1½	50534		60	Ø115	50	6,15

VÁLVULA PLATO DE DUCHA HORIZONTAL **ASIENTO CÓNICO - PLANO**
SHOWER TRAY VALVE, HORIZONTAL **CONICAL SEAT - FLAT**



				NO Sifónica			
T-65	1½	50520		65	Ø85	75	4,89





VÁLVULA PLATO DE DUCHA **ASIENTO CÓNICO - PLANO**
SHOWER TRAY VALVE **CONICAL SEAT - FLAT**



				Sifónica			
T-66	1½	50525		65	Ø85	60	4,89

VÁLVULA PLATO DE DUCHA **ASIENTO CÓNICO - PLANO**
SHOWER TRAY VALVE **CONICAL SEAT - FLAT**



REF.	SALIDA	CÓDIGO	APLICACIÓN	ALTURA	ENTRADA	U/C	PVP €
REF.	OUTLET	CODE	APPLICATION	HEIGHT	INLET	U/Box	€/pc
T-66 P	1½	50331		85	 Ø70	60	3,86
T-66 P	1½	50531		85	 Ø85	60	3,86
T-66 P	1½	50532		85	 Ø115	50	6,92
VÁLVULA PLATO DE DUCHA SIFÓNICA					ASIENTO CÓNICO - PLANO		
SHOWER TRAY VALVE WITH TRAP					CONICAL SEAT - FLAT		

NO DEPENDA DE UN HILO

Adopte Nuestro Sistema Inteligente de anclaje

strong system

● Fuerte ● Seguro ● Estanco

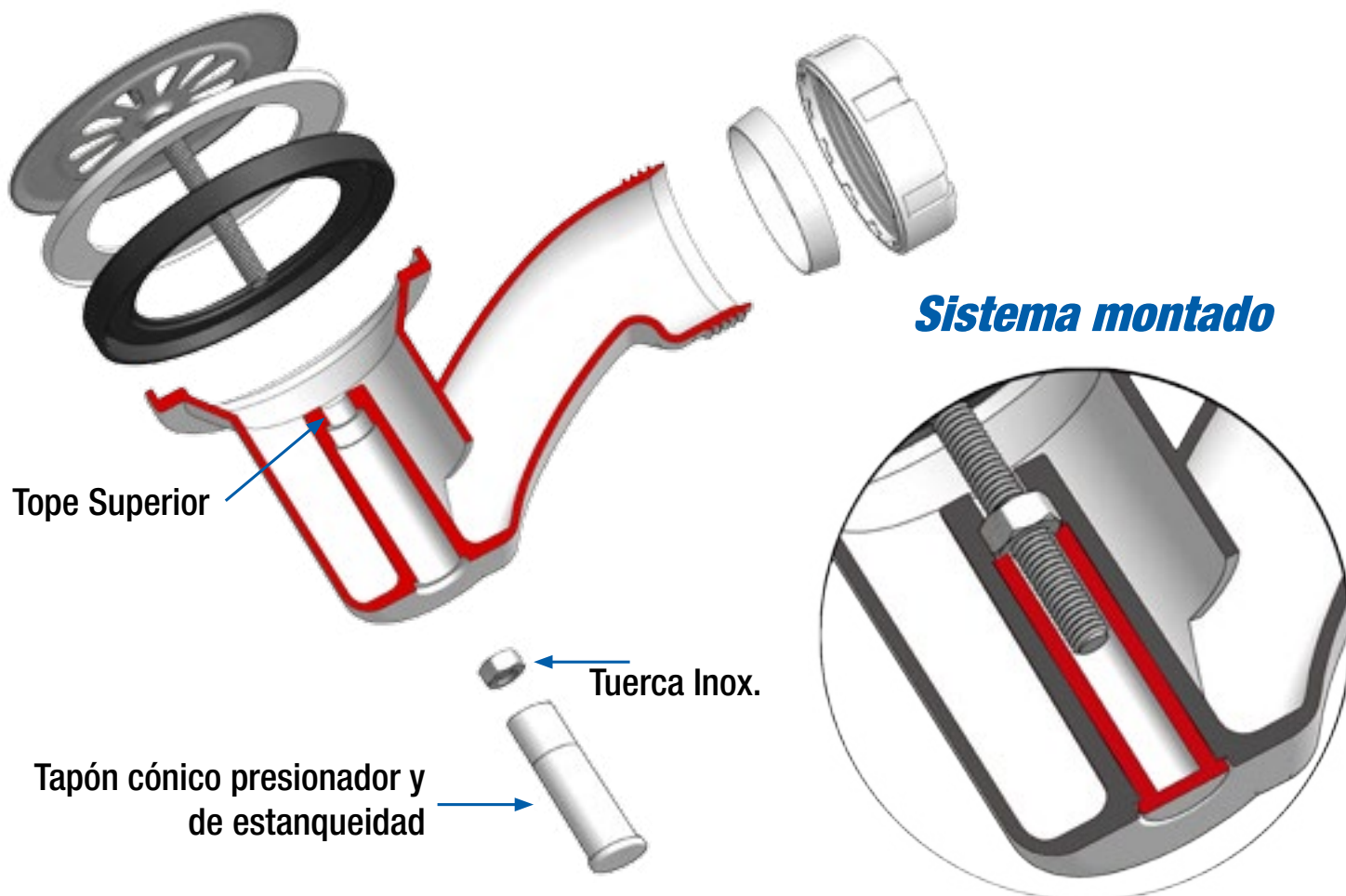

COARRUGADO



REF.	SALIDA	CÓDIGO	APLICACIÓN	ALTURA	ENTRADA	U/C	PVP €
REF.	OUTLET	CODE	APPLICATION	HEIGHT	INLET	U/Box	€/pc
T-62 C	1½	50451		—	Ø70	25	8,25

CONJUNTO BAÑERA AUTOFIJANTE SALIDA VERTICAL
 SELF-FIXING BATHTUB SET, VERTICAL OUTLET, WITH OVERFLOW

EXTRA



T-62	1½	50450		—	Ø70	25	8,69
------	----	-------	--	---	-----	----	------

CONJUNTO BAÑERA AUTOFIJANTE SALIDA VERTICAL
 SELF-FIXING BATHTUB SET, VERTICAL OUTLET, WITH OVERFLOW

COARRUGADO



T-62 C PVC	1½	50501		—	Ø70	25	9,23
---------------	----	-------	--	---	-----	----	------

CONJUNTO BAÑERA ENCOLABLE VERTICAL
 BATHTUB SET, TO BE GLUED, VERTICAL OUTLET, WITH OVERFLOW

COARRUGADO



T-63 C	1½	50506		95	Ø70	25	8,80
--------	----	-------	--	----	-----	----	------

CONJUNTO BAÑERA SALIDA HORIZONTAL
 BATHTUB SET, HORIZONTAL OUTLET, WITH OVERFLOW

EXTRA



T-63	1½	50505		95	Ø70	25	9,59
------	----	-------	--	----	-----	----	------

CONJUNTO BAÑERA SALIDA HORIZONTAL
 BATHTUB SET, HORIZONTAL OUTLET, WITH OVERFLOW

COARRUGADO





T-63 B	1½	50530		60	Ø70	25	11,14
--------	----	-------	--	----	-----	----	-------

CONJUNTO BAÑERA SALIDA HORIZONTAL
 BATHTUB SET, HORIZONTAL OUTLET, WITH OVERFLOW



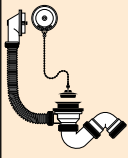

COARRUGADO

REF.	SALIDA	CÓDIGO	APLICACIÓN	ALTURA	ENTRADA	U/C	PVP €
REF.	OUTLET	CODE	APPLICATION	HEIGHT	INLET	U/Box	€/pc
T-64 C	1½	50511		115	 Ø70	25	10,40

CONJUNTO BAÑERA SIFÓNICO
SIPHONIC BATHTUB SET WITH OVERFLOW



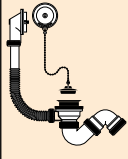

EXTRA

T-64	1½	50510		115	 Ø70	25	10,83
------	----	-------	--	-----	---	----	-------

CONJUNTO BAÑERA SIFÓNICO
SIPHONIC BATHTUB SET WITH OVERFLOW

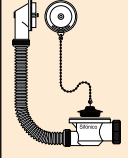

COARRUGADO

T-64 B	1½	50515		65	 Ø70	25	9,63
--------	----	-------	---	----	--	----	------



CONJUNTO BAÑERA SIFÓNICO
SIPHONIC BATHTUB SET WITH OVERFLOW

Conjunto Bañera Automático y Click-Clack

Automatic and Click-Clack bathtub set

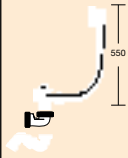

IMPORTANTE: Debido a la complejidad del sistema, será imprescindible que cuando se monte un T-64 A la bañera deberá tener un registro en la parte frontal delante del desagüe para posibles reparaciones o sustitución total de la pieza. Además, la bañera deberá **no estar integrada en la obra**, si no que su fijación y estanqueidad será mediante un elastómero tipo sicaflex.



T-64 A	1½	50029		132	 Ø70	15	39,38
--------	----	-------	--	-----	---	----	-------

CONJUNTO BAÑERA AUTOMÁTICO
AUTOMATIC BATHTUB SET WITH OVERFLOW

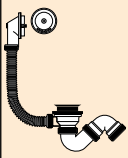

T-64 CL	1½	50512		132	 Ø70	15	34,76
---------	----	-------	--	-----	---	----	-------

CONJUNTO BAÑERA CLICK - CLACK
BATHTUB SET CLICK-CLACK



Serie Lujo

Desagües Baño

Metalizados y Cromados

Luxury Series



Válvulas Baño Lujo

FIGURA	REF.	CÓDIGO	COLOR	ALTURA	MEDIDA	U/C	P.V.P.	
PRODUCT	REF.	CODE	COLOUR	HEIGHT	SIZE	U/Box	€/pc	
	T-61-C	50401	Cromo	65	Ø70	S/P	13,65	
	T-61-C	50423	Chrome	60			1¼	13,65
	T-61-B	50403	Bronce	65			1½	34,32
	T-61-B	50426	Bronze	60			1¼	34,32
	T-61-O	50400	Oro	65			1½	24,82
	T-61-O	50427	Gold	60			1¼	24,82
	T-61-CO	50404	Cobre	65			1½	32,46
	T-61-CO	50428	Copper	60			1¼	32,46
	T-61-BL	50402	Blanco	65			1½	17,92
	T-61-BL	50429	White	60			1¼	17,92
VÁLVULA LAVABO Y BIDÉ								
WASHBASIN AND BIDET VALVE								

FIGURA	REF.	CÓDIGO	COLOR	ALTURA	MEDIDA	U/C	P.V.P. €
PRODUCT	REF.	CODE	COLOUR	HEIGHT	SIZE	U/Box	€/pc
	K-62-C	50405	CROMO / CHROME		Ø70	S/P	15,14
	K-62-B	50408	BRONCE / BRONZE				47,26
	K-62-O	50406	ORO / GOLD				34,32
	K-62-CO	50409	COBRE / COPPER				34,98
	K-62-BL	50407	BLANCO / WHITE				24,34
KIT MONTAJE PARA CONJUNTOS BAÑERA ESTÁNDAR							
ASSEMBLY KIT FOR STANDARD BATHTUB SETS							

FIGURA	REF.	CÓDIGO	COLOR	ALTURA	MEDIDA	U/C	P.V.P. €
PRODUCT	REF.	CODE	COLOUR	HEIGHT	SIZE	U/Box	€/pc
	K-61-C	50410	CROMO / CHROME		Ø70	S/P	10,34
	K-61-B	50413	BRONCE / BRONZE				33,13
	K-61-O	50411	ORO / GOLD				21,70
	K-61-CO	50414	COBRE / COPPER				32,72
	K-61-BL	50412	BLANCO / WHITE				15,86
KIT MONTAJE VÁLVULA LAVABO Y BIDET							
ASSEMBLY KIT FOR WASHBASIN AND BIDET VALVES							

FIGURA	REF.	CÓDIGO	COLOR	ALTURA	MEDIDA	U/C	P.V.P. €
PRODUCT	REF.	CODE	COLOUR	HEIGHT	SIZE	U/Box	€/pc
	T-61	40440	METALIZADO		1¼	15	20,00
	ME	40443	METALIZADO				1½
VÁLVULA METALIZADA / METALLIZED VALVE							

Válvulas Baño Lujo Click-Clack

FIGURA	REF.	CÓDIGO	COLOR	ALTURA	MEDIDA	U/C	P.V.P. €	
PRODUCT	REF.	CODE	COLOUR	HEIGHT	SIZE	U/Box	€/pc	
	T-60 CLACK ME	40110	M E T A L I Z A D O	M E T A L L I Z E D	 TECNO CLICK-GLACK	1½	15	15,00
		40111				1¼	15	15,00
VÁLVULA METALIZADA CLACK / METALLIZED CLACK VALVE								
	T-2M CLACK ME	40109	M E T A L I Z A D O	M E T A L L I Z E D	 TECNO CLICK-GLACK	Registro cónico		29,30
						1¼	DUAL	
SIFÓN BOTELLA METALIZADO CLICK-CLACK / METALLIZED BOTTLE TRAP								
	T-250 CLACK ME	40327	M E T A L I Z A D O	M E T A L L I Z E D	 TECNO CLICK-GLACK	Ø70	3	39,30
						1½		
SIFÓN BOTELLA CON ALARGADERA Y PLAFÓN / BOTTLE TRAP WITH EXTENSION AND CAP								
 Minivolumen	T-30 CLACK ME	40108	M E T A L I Z A D O	M E T A L L I Z E D	 TECNO CLICK-GLACK	Registro cónico		29,95
						1¼	DUAL	
SIFÓN CURVO CLICK CLACK / CURVED TRAP								
 Minivolumen	T-251 CLACK ME	40326	M E T A L I Z A D O	M E T A L L I Z E D	 TECNO CLICK-GLACK	Ø70	3	39,95
						1½		
SIFÓN CURVO CON ALARGADERA Y PLAFÓN / CURVED TRAP WITH EXTENSION AND CAP								

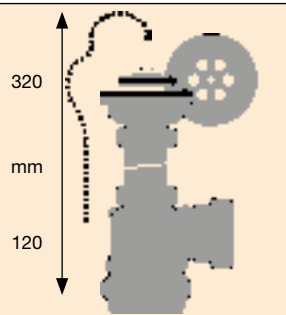
FIGURA	REF.	CÓDIGO	COLOR	ALTURA	MEDIDA	U/C	P.V.P. €
PRODUCT	REF.	CODE	COLOUR	HEIGHT	SIZE	U/Box	€/pc
	T-3-M ME	40445	M E T A L I Z A D O	M E T A L L I Z E D		Registro cónico 1¼ DUAL 1½	5 28,50

SIFÓN BOTELLA METALIZADO / METALLIZED BOTTLE TRAP

	T-250 ME	40454	M E T A L I Z A D O	M E T A L L I Z E D		Registro cónico Ø70 1½	3 38,50
--	-------------	-------	--	--	--	-------------------------------------	------------

SIFÓN BOTELLA CON ALARGADERA Y PLAFÓN / BOTTLE TRAP WITH EXTENSION AND CAP

	T-30-C ME	40444	M E T A L I Z A D O	M E T A L L I Z E D		Registro cónico 1¼ DUAL 1½	12 29,50
--	--------------	-------	--	--	--	--	-------------



SIFÓN CURVO / CURVED TRAP

	T-251 ME	40455	M E T A L I Z A D O	M E T A L L I Z E D		Registro cónico Ø70 1½	3 39,50
--	-------------	-------	--	--	--	-------------------------------------	------------

SIFÓN CURVO CON ALARGADERA Y PLAFÓN / CURVED TRAP WITH EXTENSION AND CAP

	T-38 ME	40446	M E T A L I Z A D O	M E T A L L I Z E D		Registro cónico 1¼ DUAL 1½	5 33,50
--	------------	-------	--	--	--	--	------------

SIFÓN BOTELLA CON REBOSADERO VÁLIDO 1¼-1½ / BOTTLE TRAP WITH OVERFLOW VALID FOR 1¼ AND 1½

FIGURA	REF.	CÓDIGO	COLOR	ALTURA	MEDIDA	U/C	P.V.P. €
PRODUCT	REF.	CODE	COLOUR	HEIGHT	SIZE	U/Box	€/pc
 <p>Mini volumen</p>	T-4-ME	40441	METALLIZADO	 <p>300 mm</p>	Registro cónico		14,30
		40439	METALLIZADO		100 mm	1¼ - 1½	
SIFÓN BOTELLA METALIZADO / METALLIZED BOTTLE TRAP							

 <p>NOVEDAD Mini volumen</p>	T-260ME	40471	METALLIZADO	 <p>320 mm</p> <p>120 mm</p> <p>250 mm</p>	Registro cónico		24,30
					METALLIZADO	1¼	
SIFÓN BOTELLA CON ALARGADERA Y PLAFÓN / BOTTLE TRAP WITH EXTENSION AND CAP							

 <p>Mini volumen</p>	T-31ME	40442	METALLIZADO	 <p>315 mm</p> <p>115 mm</p>	Registro cónico		14,95
		40438	METALLIZADO			1¼ - 1½	
SIFÓN CURVO / CURVED TRAP							

 <p>NOVEDAD Mini volumen</p>	T-261ME	40431	METALLIZADO	 <p>335 mm</p> <p>135 mm</p> <p>250 mm</p>	Registro cónico		24,95
					METALLIZADO	1¼	
SIFÓN CURVO CON ALARGADERA Y PLAFÓN / CURVED TRAP WITH EXTENSION AND CAP							

 <p>Mini volumen</p>	T-68ME	40325	METALLIZADO	 <p>320 mm</p> <p>120 mm</p>	1¼	10	25,00
					METALLIZADO		
VÁLVULA CON REBOSADERO / VALVE WITH OVERFLOW							

FIGURA	REF.	CÓDIGO	COLOR	ALTURA	MEDIDA	U/C	P.V.P. €
PRODUCT	REF.	CODE	COLOUR	HEIGHT	SIZE	U/Box	€/pc



T-79 ME	40463	M E T A L L I Z A D O	M E T A L L I Z E D		1½	4	25,00
------------	-------	---	--	--	----	---	-------

DESAGÜE URINARIO / URINAL WASTE OUTLET



T-79C ME	40464	M E T A L L I Z A D O	M E T A L L I Z E D		1½	3	20,00
-------------	-------	---	--	--	----	---	-------

DESAGÜE URINARIO ACODADO CON PLAFÓN URINAL ELBOW WASTE OUTLET WITH CAP

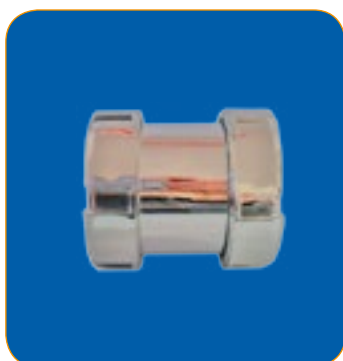

T-206 ME	40831	M E T A L L I Z A D O	M E T A L L I Z E D	CONEXIONES CONNECTIONS	1¼	25	3,95
	40830				1½	25	3,95

MANGUITO HEMBRA-HEMBRA / CONNECTOR, FEMALE-FEMALE



T-200 ME	40462	M E T A L L I Z A D O	M E T A L L I Z E D	CONEXIONES CONNECTIONS	1¼	20	4,15
	40452				1½	15	4,15

CODO HEMBRA-HEMBRA / ELBOW, FEMALE-FEMALE



T-201 ME	40806	M E T A L L I Z A D O	M E T A L L I Z E D	CONEXIONES CONNECTIONS	1¼	20	4,25
	40805				1½	15	4,25

CODO MACHO-HEMBRA / ELBOW, MALE-FEMALE

FIGURA	REF.	CÓDIGO	COLOR	ALTURA	MEDIDA	U/C	P.V.P. €
PRODUCT	REF.	CODE	COLOUR	HEIGHT	SIZE	U/Box	€/pc



T-39 D ME	40039	M E T A L L I Z A D O	M E T A L L I Z E D	<p>CONVERSOR 1 1/4</p> <p>1 1/2 Ø 32 Ø 40</p>	1 1/2	10	12,25
--------------	-------	---	--	---	-------	----	-------

SIFÓN EXTENSIBLE DUAL CON TUERCA LOCA / *DUAL FLEXIBLE TRAP WITH SLIP NUT*



T-39 ME	40456	M E T A L L I Z A D O	M E T A L L I Z E D	<p>1 1/4 Ø 32 Ø 40</p>	1 1/4	10	11,50
T-39 ME	40459	M E T A L L I Z A D O	M E T A L L I Z E D	<p>1 1/2 Ø 32 Ø 40</p>	1 1/2	10	11,50

SIFÓN EXTENSIBLE / *EXTENSIBLE TRAP*



T-245 ME	40245	M E T A L L I Z A D O	M E T A L L I Z E D	<p>1 1/4 Ø 32</p>	1 1/4	20	13,68
T-245 ME	40246	M E T A L L I Z A D O	M E T A L L I Z E D	<p>1 1/2 Ø 40</p>	1 1/2	20	13,94

VALVULA AIREACIÓN CROMADA / *CHROMED AIR VALVE CONECTOR*



T-312 ME	40193	M E T A L L I Z A D O	M E T A L L I Z E D	<p>Ø 10-25</p>	Ø 10-25	200	2,95
-------------	-------	---	--	----------------	---------	-----	------

PLAFÓN EMBELLECEDOR PLANO ABIERTO CROMADO / *OPEN WALL CAP CHROMED*



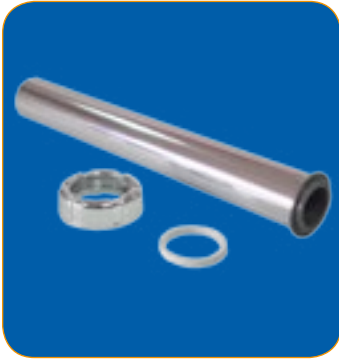

T-211 ME	40453	M E T A L L I Z A D O	M E T A L L I Z E D	<p>80 x 40</p> <p>Ø 32</p>	Ø 32	20	3,38
T-211 ME	40447	M E T A L L I Z A D O	M E T A L L I Z E D	<p>80 x 40</p> <p>Ø 40</p>	Ø 40	20	3,38

PLAFÓN / *CAP*

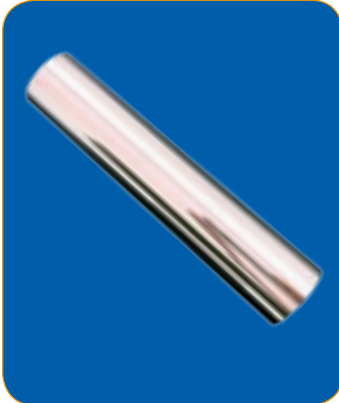

T-204 C ME	40823	METALIZADO	METALLIZED	250 CONEXIONES CONNECTIONS	Ø32 1¼	20	6,07
ALARGADERA PVC METALIZADA Ø32 PARA RECIBIR VÁLVULAS CLICK-CLACK PVC EXTENSION Ø32 FOR CLICK-CLACK VALVES							

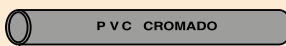

T-204 ME	40448	METALIZADO	METALLIZED	PVC CHROMED	Ø32x250	20	4,39	
	40449				Ø32x500	45	6,65	
	40345				Ø32x1000	S/P	14,95	
	40450				Ø40x250	16	4,88	
	40451					Ø40x500	30	8,57
	40346				Ø40x1000	S/P	18,85	
ALARGADERA PVC CROMADA ENCOLABLE CHROMED PVC EXTENSION TO BE GLUED								

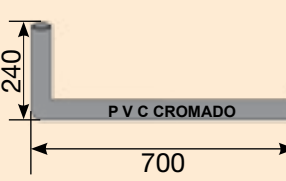

T-404 ME	40348	METALIZADO	METALLIZED	PVC CHROMED 	Ø32 700 x 240	S/P	19,95
ALARGADERA ACODADA PVC CROMADA ENCOLABLE CHROMED PVC SILLED EXTENSION TO BE GLUED							



NOVEDAD

Sifones Latón Cromo Alta Calidad

High quality chromed brass traps

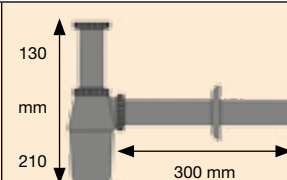

REF.	CÓDIGO	COTAS	SALIDA	U/C	P.V.P. €
REF.	CODE	DIMENSIONS	OUTLET	U/Box	€/pc.
T-40	50078		1 1/4"	9	26,00

SIFÓN LATÓN CROMADO BOTELLA LAVABO
CHROMED BRASS WASHBASIN BOTTLE TRAP

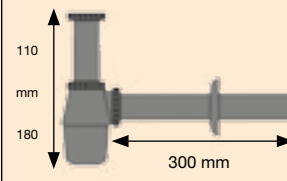

T-40-B	50084		1 1/4"	9	23,00
--------	-------	--	--------	---	-------

SIFÓN LATÓN CROMADO BOTELLA BIDÉ
CHROMED BRASS BIDET BOTTLE TRAP

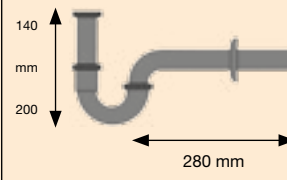

T-41	50079		1 1/4"	12	18,00
------	-------	--	--------	----	-------

SIFÓN CURVO LATÓN CROMADO LAVABO
CHROMED BRASS WASHBASIN CURVED TRAP

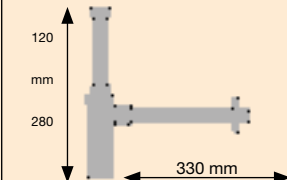

T-300-R	50091		1 1/4"	8	45,00
---------	-------	--	--------	---	-------

SIFÓN BOTELLA CROMADO STYLE REDONDO
CHROMED BRASS BOTTLE TRAP, ROUND

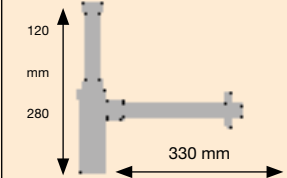

T-300-C	50092		1 1/4"	8	50,00
---------	-------	--	--------	---	-------

SIFÓN BOTELLA CROMADO STYLE CUADRADO
CHROMED BRASS BOTTLE TRAP, SQUARE

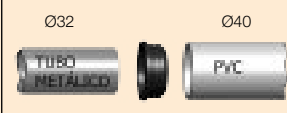

T-229	50720		40	60	1,29
-------	-------	--	----	----	------

JUNTA UNIÓN A TUBO METÁLICO
UNION BOARD METAL TUBE

Botes Sifónicos

Manguitos inodoro

*Floor Traps
WC pan connectors*





Botes Sifónicos Serie Estándar Altura 85 mm

T-85

Cod. 50605

U/C 20 P.V.P.: 7,49 €

T-85 A

Cod. 50608

U/C 20 P.V.P.: 9,59 €

T-85 S

Cod. 50600

U/C 20 P.V.P.: 7,49 €

Bote con
Tapa Expansiva



Bote con
Tapa Aireación



Bote con
Tapa Sumidero



Instrucciones Gráficas para Forjados

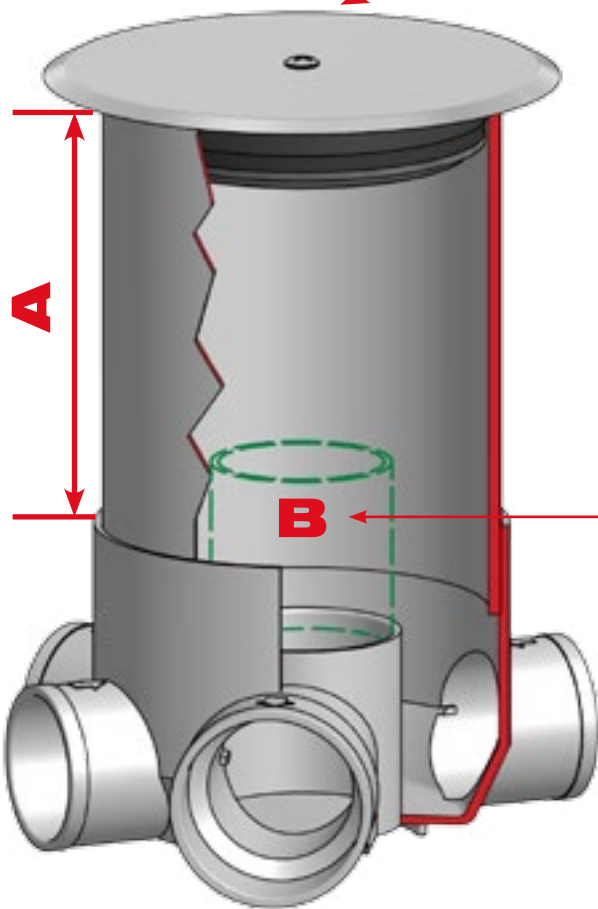

A

Altura modificable con tubo PVC Ø110 según necesidad



B

Para olores extremos modificar con tubo PVC Ø50 nivel de sifonaje

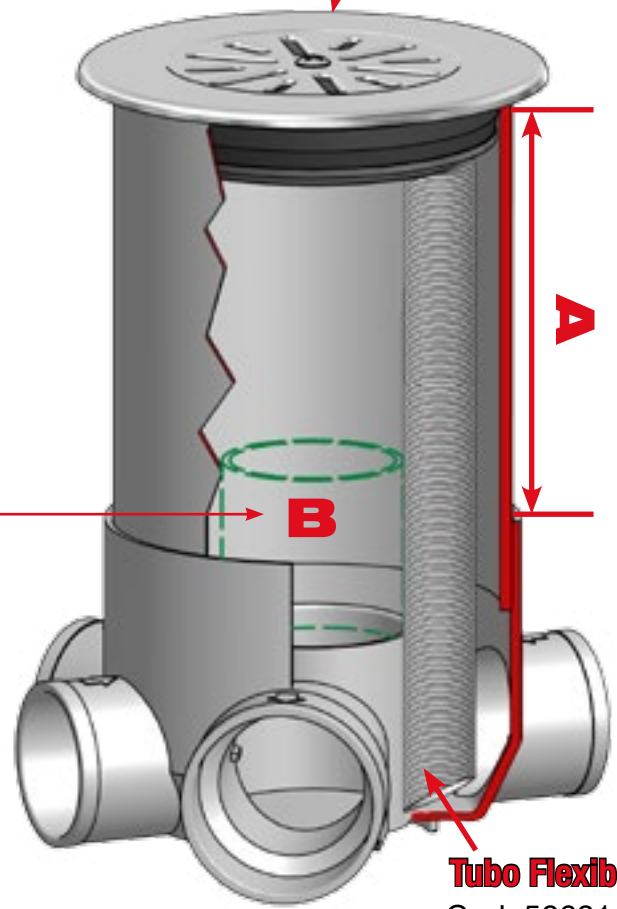

Tubo Flexible

Cod. 50631

U/C S/P

P.V.P.: 1,58 €

T-89ST

Botes Sifónicos Serie Baja Altura 75mm

T-85 B

Cod. 50606

U/C 25 P.V.P.: 9,46 €



T-85 BA

Cod. 50620

U/C 25 P.V.P.: 11,56 €



T-85 BS

Cod. 50609

U/C 25 P.V.P.: 9,46 €

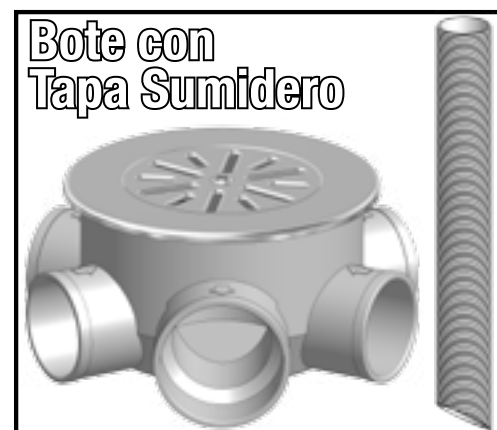

Bote con Tapa Cónica

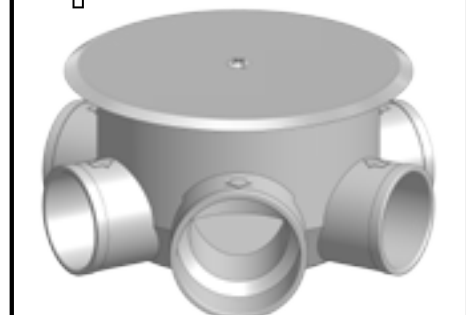

T-85 C

Cod. 50607

U/C 25
P.V.P.: 9,46 €

REDUCCIÓN

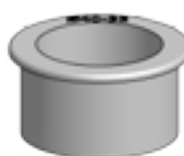

50622 CR Ø40-32
U/C: 70 PVP: 0,40 €

50670 CR Ø50-40
U/C: 30 PVP: 0,60 €

TAPÓN



52152 TO Ø40
U/C: 100 PVP: 0,37 €

52153 TO Ø50
U/C: 30 PVP: 0,48 €

Tapas de Botes Sifónicos

T-89

Tapa Expansiva



Cod. 50617

U/C 50

P.V.P.: 4,89 €

T-89A

Tapa Aireación



Cod. 50618

U/C 10

P.V.P.: 6,99 €

T-89S

Tapa Sumidero



Cod. 50621

U/C 25

P.V.P.: 4,89 €

T-89E

Tapa Cónica



Cod. 50624

U/C 10

P.V.P.: 4,89 €

Compatible con bote de 3 tornillos.
Para soluciones de 2 tornillos consultar.

Manguitos Inodoro

WC pan connectors



REF.	SALIDA	CÓDIGO	APLICACIÓN	ALTURA	ENTRADA	U/C	PVP €
REF.	OUTLET	CODE	APPLICATION	HEIGHT	INLET	U/Box	€/pc
T-90	Ø90	50610		130	Ø90	50	4,11
T-90-E	Ø90	50615		130 (EX. 2cm)	Ø90	50	4,11

MANGUITO INODORO RECTO / EXCÉNTRICO
WC PAN CONNECTOR, STRAIGHT / ECCENTRIC



T-110	Ø110	50613		130	Ø90	40	4,11
-------	------	-------	---	-----	-----	----	------

MANGUITO INODORO RECTO
WC PAN CONNECTOR, STRAIGHT



T-90-L	Ø110	50612		130	Ø90	50	4,89
T-90-EL	Ø110	50614		130 (EX. 2cm)	Ø90	50	4,89

MANGUITO INODORO CON JUNTA LABIADA RECTO / EXCÉNTRICO
WC PAN CONNECTOR WITH LIP SEAL, STRAIGHT / ECCENTRIC



T-111	Ø90	50688		—	Ø90	80	2,30
-------	-----	-------	--	---	-----	----	------

JUNTA PARA MANGUITO INODORO
GASKET FOR WC PAN CONNECTOR



T-112	Ø110	50675		—	Ø90	75	2,30
-------	------	-------	--	---	-----	----	------

JUNTA LABIADA PARA MANGUITO INODORO
LIP GASKET FOR WC PAN CONNECTOR



REF.	SALIDA	CÓDIGO	APLICACIÓN	ALTURA	ENTRADA	U/C	PVP €
REF.	OUTLET	CODE	APPLICATION	HEIGHT	INLET	U/Box	€/pc
T-117	Ø110	50674		DISTANCIA A PARED DISTANCE TO THE WALL 150	Ø90	30	14,56
MANGUITO INODORO SENSO							
<i>WC PAN CONNECTOR SENSO</i>							



T-122	Ø110	50704		DISTANCIA A PARED DISTANCE TO THE WALL 210	Ø90	30	14,56
MANGUITO INODORO SENSO							
<i>WC PAN CONNECTOR SENSO</i>							



T-125	270 mm	50725		PARA MANGUITO T-122 y T-117		15	2,83
SISTEMA FIJACIÓN MANGUITO INODORO 270 mm							
<i>PAN CONNECTOR SCREW FIXING</i>							



T-119	Ø110	50703		(EX. 9cm)	Ø90	20	11,19
MANGUITO INODORO MÁXIMO DESPLAZAMIENTO							
<i>WC PAN CONNECTOR WITH MAX. DISPLACEMENT</i>							

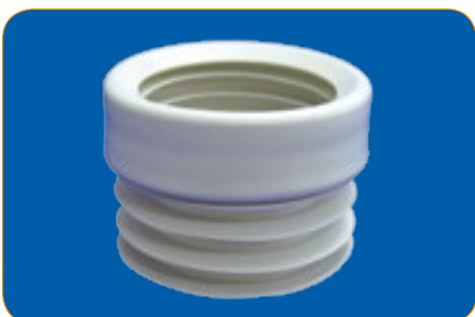

T-113	Ø110	50676		100	Ø90	35	4,78
MANGUITO RECTO INODORO FLEXIBLE Y LABIADO							
<i>WC PAN CONNECTOR, STRAIGHT, FLEXIBLE, LABIATE</i>							



T-114	Ø110	50677		100 (EX. 4cm)	Ø90	35	4,78
MANGUITO EXCÉNTRICO INODORO FLEXIBLE Y LABIADO							
<i>WC PAN CONNECTOR, ECCENTRIC, FLEXIBLE, LABIATE</i>							

Manguitos Inodoro Flexible

Flexible WC pan connectors

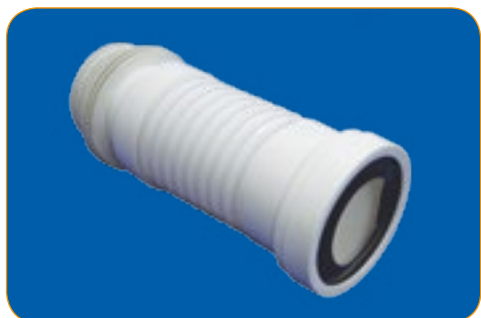

REF.	SALIDA	CÓDIGO	APLICACIÓN	ALTURA	ENTRADA	U/C	PVP €
REF.	OUTLET	CODE	APPLICATION	HEIGHT	INLET	U/Box	€/pc
T-115	Ø90-110	50678		380	Ø90	23	17,38
MANGUITO ORIENTABLE CORTO						INTERIOR LISO	
WC PAN CONNECTOR, ADJUSTABLE, SHORT						SMOOTH INTERIOR	

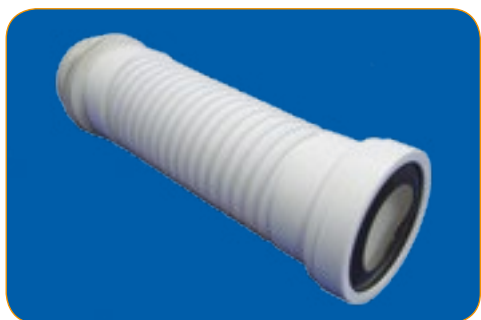

T-116	Ø90-110	50679		550	Ø90	16	17,94
MANGUITO ORIENTABLE LARGO						INTERIOR LISO	
WC PAN CONNECTOR, ADJUSTABLE, LONG						SMOOTH INTERIOR	

Manguitos Inodoro Extensible

Extensible WC pan connectors



T-118	Ø90-110	50702		230 570	Ø90	18	18,61
MANGUITO ORIENTABLE Y EXTENSIBLE (CON REFUERZO METÁLICO)							
WC PAN CONNECTOR, ADJUSTABLE, EXTENSIBLE							



T-118M	Ø90-110	50701		180 350	Ø90	8	17,25
MINI MANGUITO INODORO EXTENSIBLE (CON REFUERZO METÁLICO)							
EXTENSIBLE PAN CONNECTOR SHORT							

Manguitos Inodoro Cisterna Empotrada

WC Concealed Cisterns pan connectors

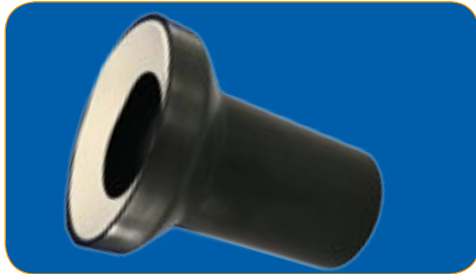

REF.	SALIDA	CÓDIGO	APLICACIÓN	ALTURA	ENTRADA	U/C	PVP €
REF.	OUTLET	CODE	APPLICATION	HEIGHT	INLET	U/Box	€/pc
T-127	Ø90	50707		170	Ø90	10	11,00

MANGUITO INODORO RECTO NEGRO

WC BLACK PAN CONNECTOR, STRAIGHT



T-128	Ø90	50708		220	Ø90	8	16,00
-------	-----	-------	--	-----	-----	---	-------

CODO DESAGÜE INODORO

WC BLACK PAN CONNECTOR, ELBOW



Conversor
Manguito
Ø90 a Ø110

T-129	Ø90-110	50709		100	Ø90	15	10,00
-------	---------	-------	--	-----	-----	----	-------

CONVERSOR MANGUITO 90 -110

90-110 CONVERTOR PAN CONNECTOR

Manguitos Inodoro Acortable PVC

WC pan cuttable connectors

T-120 XL

Mang. Inodoro Acortable PVC (650-160)

Shortenable pan connector

Código: 50706

U/C: 2

P.V.P. 53,34 €



T-120

Mang. Inodoro Acortable PVC (350-160)

Shortenable pan connector

Código: 50705

U/C: 4

P.V.P. 48,48 €





Sumideros y Canaletas

Floor drains and channels



Formando el Futuro

Sumideros

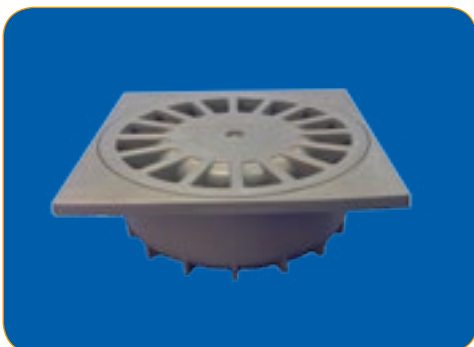

REF.	SALIDA	CÓDIGO	APLICACIÓN	ALTURA	MEDIDA	U/C	PVP €
REF.	OUTLET	CODE	APPLICATION	HEIGHT	SIZE	U/B	€/pc
T-88	Ø125	50452		105	30X30	5	20,99
T-88	Ø110-90	50632		70	25X25	13	14,34
T-88	Ø110-90	50633		70	20X20	15	11,04
T-88	Ø50	50440		50	15X15	24	6,07
T-88	Ø40	50601		45	10X10	40	5,51
T-88	Ø75-50	50636	NO TURBO SYSTEM	55	15X15	40	6,07

SUMIDERO VERTICAL

VERTICAL FLOOR DRAIN



T-84	Ø110-90	50360		25X25	6	4,50
T-84	Ø50	50361		20X20	5	2,25
T-84	Ø40	50362		15X15	12	1,69

CODO 360°

ELBOW 360°

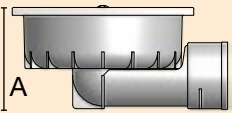

T-88-VH	Ø110-90	50884		140	25X25	6	17,87
T-88-VH	Ø110-90	50883		140	20X20	8	14,89
T-88-VH	Ø50	50882		85	15X15	30	7,46
T-88-VH	Ø40	50881		70	10X10	25	6,46

SUMIDERO VERTICAL-HORIZONTAL VERTICAL-HORIZONTAL FLOOR DRAIN

Calderetas



T-86-V	Ø125	50629		180	30X30	3	27,29
T-86-V	Ø110-90	50628		130	25X25	5	20,96
T-86-V	Ø110-90	50630		130	20X20	6	17,65
T-86-V	Ø50	50696		90	15X15	20	11,04
T-86-V	Ø40	50697		80	10X10	15	9,93

CALDERETA VERTICAL

VERTICAL FLOOR DRAIN TRAPPED

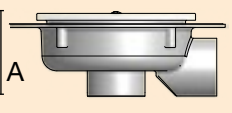

T-86-VH	Ø110-90	50639		145	25X25	5	21,51
T-86-VH	Ø110-90	50604		145	20X20	6	18,20
T-86-VH	Ø50	50441		90	15X15	20	11,58
T-86-VH	Ø40	50602		65	10X10	15	10,48
T-86VH	Ø75-50	50640		NO TURBO SYSTEM	98	15X15	25

CALDERETA VERTICAL-HORIZONTAL VERTICAL-HORIZONTAL FLOOR DRAIN TRAPPED





T-86-H	Ø110-90	50642		140	25X25	5	20,96
T-86-H	Ø110-90	50644		140	20X20	6	17,65

CALDERETA HORIZONTAL

HORIZONTAL FLOOR DRAIN TRAPPED

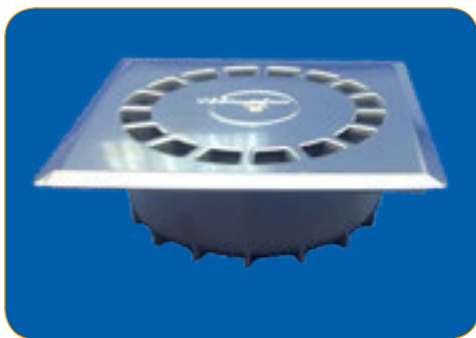
Sumideros Inox



REF.	SALIDA	CÓDIGO	APLICACIÓN	ALTURA	MEDIDA	U/C	PVP €
REF.	OUTLET	CODE	APPLICATION	HEIGHT	SIZE	U/B	€/pc
T-88-I	Ø110-90	50685		70	20X20	15	22,34
T-88-I	Ø50	50442		50	15X15	24	12,90
T-88-I	Ø40	50687		45	10X10	40	8,43
T-88-I	Ø75-50	50686	NO TURBO SYSTEM	55	15x15	36	12,90

SUMIDERO INOX VERTICAL
VERTICAL STAINLESS STEEL FLOOR DRAIN

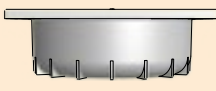

T-84	Ø110-90	50360		25X25	6	4,50
T-84	Ø50	50361		20X20		
T-84	Ø40	50362		15X15	5	2,25
				10X10	12	1,69

CODO 360°
ELBOW 360°

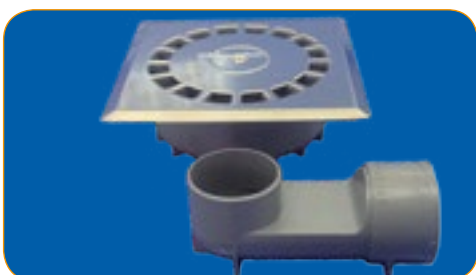

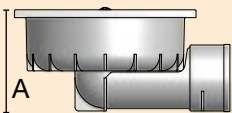
T-88-VHI	Ø110-90	50885		140	20X20	8	27,31
T-88-VHI	Ø50	50887		85	15X15	30	14,89
T-88-VHI	Ø40	50890		70	10X10	25	9,93

SUMIDERO INOX VERTICAL-HORIZONTAL
VERTICAL-HORIZONTAL STAINLESS STEEL FLOOR DRAIN

Calderetas Inox

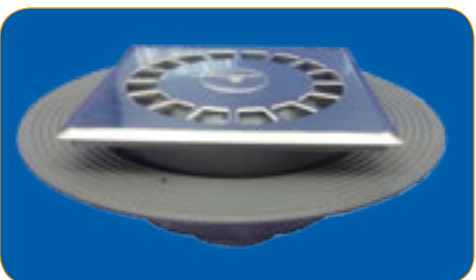

T-86-VI	Ø110-90	50680		130	20X20	6	28,29
T-86-VI	Ø50	50987		90	15X15	20	17,38
T-86-VI	Ø40	50988		80	10X10	15	12,41

CALDERETA INOX VERTICAL
VERTICAL STAINLESS STEEL FLOOR DRAIN TRAPPED

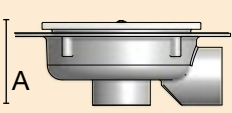

T-86-VHI	Ø110-90	50689		145	20X20	6	28,79
T-86-VHI	Ø50	50443		90	15X15	20	17,87
T-86-VHI	Ø40	50682		65	10X10	15	12,90
T-86-VHI	Ø75-50	50681		NO TURBO SYSTEM	150	15x15	25

CALDERETA INOX VERTICAL-HORIZONTAL
VERTICAL-HORIZONTAL STAINLESS STEEL FLOOR DRAIN TRAPPED



T-86-HI	Ø110-90	50684		140	20X20	6	28,29
---------	---------	-------	--	-----	-------	---	-------

CALDERETA INOX HORIZONTAL
HORIZONTAL STAINLESS STEEL FLOOR DRAIN TRAPPED



REF.	OUTLET	CODE	APPLICATION	HEIGHT	SIZE	U/B	€/pc
T-88 F	Ø90-110	50693	 B125	70	25X25	4	67,58
SUMIDERO FUNDICIÓN							
<i>IRON FLOOR DRAIN</i>							



T-88 RF	—	50694	Recambio Rejilla Fundición B125	-	25X25	4	41,46
REJILLA SUMIDERO FUNDICIÓN							
<i>IRON FLOOR DRAIN GRID</i>							

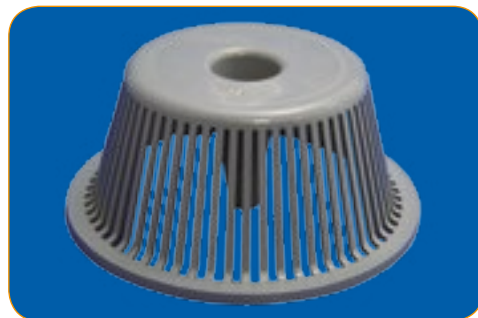

T-91	21cm	50641		90	VALIDO 25X25 20X20 15X15	18	7,42
SOMBRERO ANTIGRAVILLA PARA CALDERETAS							
<i>ANTI GRAVEL CAP GRID FOR OUTDOORS FLOOR GULLY</i>							



PVC

T-87	50-40	50638		CONVENCIONAL 90	10X10	50	6,46
SUMIDERO SIFÓNICO SALIDA HORIZONTAL Y VERTICAL							
<i>PVC FLOOR DRAIN, SIPHONIC, HORIZONTAL AND VERTICAL OUTLET</i>							

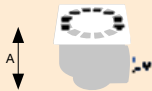

INOX

T-87 I	50-40	50637		CONVENCIONAL 90	10X10	50	9,28
SUMIDERO SIFÓNICO SALIDA HORIZONTAL Y VERTICAL INOX							
<i>FLOOR DRAIN, SIPHONIC, HORIZONTAL AND VERTICAL OUTLET STAINLESS STEEL GRID</i>							



LUJO INOX

T-87 LI	50-40	50616		CONVENCIONAL 90	10X10	50	16,73
SUMIDERO SIFÓNICO SALIDA HORIZONTAL Y VERTICAL INOX							
<i>FLOOR DRAIN, SIPHONIC, HORIZONTAL AND VERTICAL OUTLET STAINLESS STEEL GRID</i>							

Ahorra Stock Combinándolos Elementos Sueltos 10x10

A	B	C	D	E
				
STANDARD INOX T-510 - 50652 U/C: 20 P.V.P. 3,62 €	LINEAL INOX T-520 N - 50578 U/C: 20 P.V.P. 8,57 €	DIAGONAL INOX T-520 D - 50577 U/C: 20 P.V.P. 6,43 €	LUJO INOX T-520 L - 50563 U/C: 20 P.V.P. 10,71 €	LUJO ABS T-511 L - 50655 U/C: 20 P.V.P. 4,28 €

Sumidero



T-88 - 50601
U/C: 40
P.V.P. 5,51 €

Sumidero VH



T-88 VH - 50881
U/C: 25
P.V.P. 6,46 €

Caldereta VH



T-86 VH - 50602
U/C: 15
P.V.P. 10,48 €



T-84 - 50362
U/C: 12
P.V.P. 1,69 €

* Este modelo incluye aro y tornillos prensatela

Conjuntos 10x10

	+				
A		T-88 I 50687 - U/C:40 P.V.P.: 8,43 €	T-88 VHI 50890 - U/C:25 P.V.P.: 9,93 €	T-86 VHI 50682 - U/C:15 P.V.P.: 12,90 €	T-86 VHIA 50482 - U/C:15 P.V.P.: 28,21 €
B		T-88 N 50445 - U/C:40 P.V.P.: 13,90 €	T-88 VHN 50891 - U/C:30 P.V.P.: 15,39 €	T-86 VHN 50455 - U/C:15 P.V.P.: 18,36 €	T-86 VHNA 50483 - U/C:15 P.V.P.: 33,16 €
C		T-88 D 50444 - U/C:40 P.V.P.: 11,92 €	T-88 VHD 50892 - U/C:30 P.V.P.: 13,40 €	T-86 VHD 50454 - U/C:15 P.V.P.: 16,38 €	T-86 VHDA 50484 - U/C:15 P.V.P.: 31,02 €
D		T-88 LI 50446 - U/C:40 P.V.P.: 15,89 €	T-88 VHLI 50893 - U/C:30 P.V.P.: 17,38 €	T-86 VHLI 50456 - U/C:15 P.V.P.: 20,35 €	T-86 VHLIA 50485 - U/C:15 P.V.P.: 35,30 €
E		T-88 L 50447 - U/C:40 P.V.P.: 9,93 €	T-88 VHL 50894 - U/C:30 P.V.P.: 11,42 €	T-86 VHL 50457 - U/C:15 P.V.P.: 14,40 €	T-86 VHLA 50486 - U/C:15 P.V.P.: 28,87 €

Elementos Suelto Sumideros y Calderetas

Sombreros



REF.	SALIDA	CÓDIGO	APLICACIÓN	ALTURA	MEDIDA	U/C	PVP €
REF.	OUTLET	CODE	APPLICATION	HEIGHT	SIZE	U/B	€/pc
T-186 V	Ø125	55629		180	30X30	4	12,01
T-186 V	Ø110-90	55628		130	25X25	8	9,22
T-186 V	Ø110-90	55630		130	20X20	8	7,77
T-186 V	Ø50	55696		90	15X15	30	4,85
T-186 V	Ø40	55697		80	10X10	50	4,37

SOMBRERO VERTICAL

VERTICAL FLOOR DRAIN

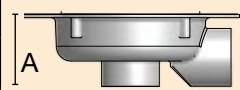

T-186 VH	Ø110-90	55639		145	25X25	6	9,47
T-186 VH	Ø110-90	55604		145	20X20	6	8,00
T-186 VH	Ø50	55441		90	15X15	25	5,09
T-186 VH	Ø40	55640		65	10X10	40	4,85
T-186 VH	Ø75	55602		NO TURBO SYSTEM	98	15X15	15

SOMBRERO VERTICAL - HORIZONTAL

VERTICAL - HORIZONTAL FLOOR DRAIN



T-186 H	Ø110-90	55642		140	25X25	6	9,22
T-186 H	Ø110-90	55644		140	20X20	6	7,76

SOMBRERO VERTICAL - HORIZONTAL

VERTICAL - HORIZONTAL FLOOR DRAIN

Rejillas



T-87 R	1	50949		40	10X10	S/P	3,32
T-88R		50649		40	10X10	S/P	3,32
T-88 R	2	50648		50	15X15	S/P	4,93
T-88 R		50647		50	20X20	S/P	5,97
T-88 R		50646		50	25X25	S/P	7,79
T-88 R		50645		50	30X30	S/P	11,97

REJILLA SUMIDERO SIFÓNICO PVC

PVC FLOOR DRAIN GRATING

Codo 360°



T-84	Ø90-Ø110	50360		25X25	6	4,50
T-84	Ø50	50361		15X15		
T-84	Ø40	50362		10X10	12	1,69

CODO 360° AHORRO ESPACIO SUMIDEROS

ELBOW 360°

Canaletas

Serie 1000

Serie 500

Garaje y Piscina



Canaletas

Serie 1000 Rejilla Metálica



A-15

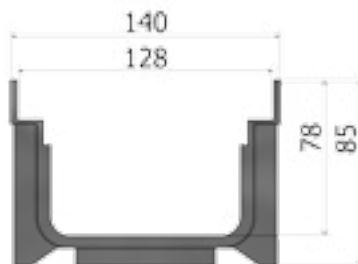

**Canaleta con
Rejilla Metálica**



incluye Kit antirrobo

REF.	CÓDIGO	MED./ÁNGULO	U/C	PVP €
REF.	CODE	DIM./ANGLE	U/Box	€/pc

T-160 AG	50157	1000 x 140 x 85 Ø75- Ø80-Ø100	S/P	31,03
-------------	-------	---	-----	-------

CANALETA CON REJILLA ACERO GALVANIZADO

PP CHANNEL WITH GRID

**Cuerpo Canaleta
PP**



T-161 AG	50158	1000 x 140 x 85 Ø75- Ø80-Ø100	S/P	12,95
-------------	-------	---	-----	-------

CANALETA POLIPROPILENO NEGRO

PP CHANNEL

Rejilla Metálica

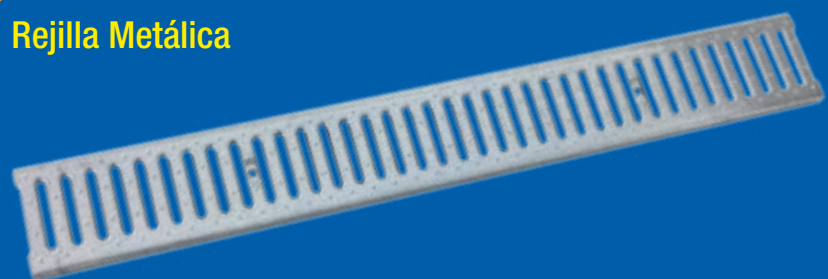

T-162 AG	50159	1000 x 128	S/P	16,21
-------------	-------	------------------	-----	-------

REJILLA CANALETA ACERO GALVANIZADO

GALVANISED STEEL GRID



Kit

T-164 AG	50161	KIT ANTIRROBO	S/P	1,86
-------------	-------	------------------	-----	------

SISTEMA ANTIRROBO PARA CANALETA DE 1000x85

ANTI-THEFT SYSTEM



T-163 AG	50160	Ø60	S/P	2,68
-------------	-------	-----	-----	------

TAPA TERMINAL PARA CANALETA DE 1000x140x85

CHANNEL CAP

Extrabajaja Serie 1000



A-15

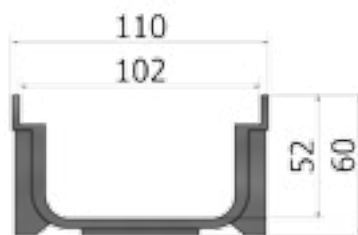

**Canaleta con
Rejilla Metálica**



REF.	CÓDIGO	MED./ÁNGULO	U/C	PVP €
REF.	CODE	DIM./ANGLE	U/Box	€/pc

T-150 AG	50149	1000 x 110 x 60 Ø40-Ø50-Ø75	S/P	26,89
-------------	-------	--	-----	-------

CANALETA CON REJILLA ACERO GALVANIZADO

PP CHANNEL WITH GALVANISED STEEL GRID

**Canaleta con
Rejilla PP**



T-150 PP	50152	1000 x 110 x 60 Ø40-Ø50-Ø75	S/P	21,58
-------------	-------	--	-----	-------

CANALETA CON REJILLA POLIPROPILENO NEGRO

PP CHANNEL WITH BLACK PP GRID

**Cuerpo Canaleta
PP**



T-151 AG	50153	1000 x 110 x 60 Ø40-Ø50-Ø75	S/P	12,26
-------------	-------	--	-----	-------

CANALETA POLIPROPILENO NEGRO

PP CHANNEL

**Rejilla Suelta
PP**

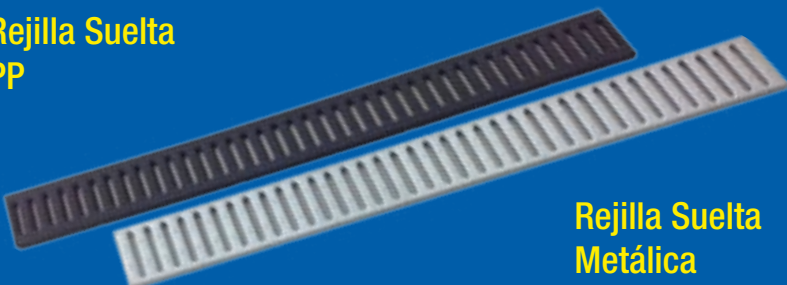

**Rejilla Suelta
Metálica**

T-152 AG	50154	1000 x 102	S/P	14,63
T-152 PP	50155	1000 x 102	S/P	9,49

REJILLA ACERO GALVANIZADO / PP NEGRO

GALVANISED STEEL GRID / PP BLACK



T-153 AG	50156	Ø40	S/P	2,46
-------------	-------	-----	-----	------

TAPA TERMINAL PARA CANALETA DE 1000x110x60

CHANNEL CAP

Canaletas Serie Alta

High series channels

**Canaleta con
Rejilla Fundición**



REF.	SALIDA	CÓDIGO	APLICACIÓN	COLOR	MED./ÁNGULO	U/C	PVP €
REF.	OUTLET	CODE	APPLICATION	COLOUR	DIM./ANGLE	U/Box	€/pc
T-140	Ø90	50692	 D-400	GRIS GREY	 500X130X130	2	50,21

CANALETA PVC CON REJILLA FUNDICIÓN

PVC CHANNEL WITH IRON GRID

**Rejilla suelta
Fundición**



T-141	---	50691	 D-400	GRIS GREY	500X130	5	41,46
-------	-----	-------	-----------	--------------	---------	---	-------

REJILLA CANALETA FUNDICIÓN

IRON CHANNEL GRID

**Canaleta con
Rejilla PVC**



T-130-G	Ø90	50656	 A-15	GRIS GREY	 500X130X130	4	18,80
---------	-----	-------	----------	--------------	-----------------	---	-------

CANALETA CON REJILLA PVC

PVC CHANNEL WITH GRID

2

1



3

Elementos PVC

T-132-G		50659	1	GRIS	45°	15	4,63
---------	--	-------	---	------	-----	----	------

REJILLA PVC MULTIDIRECCIONAL

T-131-G		50657	2	GRIS	45°	6	10,25
---------	--	-------	---	------	-----	---	-------

CODO CON REJILLA PVC MULTIDIRECCIONAL

T-133	Ø110	50658	3	GRIS	45°	6	3,44
-------	------	-------	---	------	-----	---	------

COMPACTO SALIDA CON TAPÓN

**Rejilla Suelta
PVC**



T-134-G	---	50660		GRIS GREY	500X130	20	9,32
---------	-----	-------	--	--------------	---------	----	------

COMPACTO SALIDA CON TAPÓN

COMPACT OUTLET WITH CAP

**Cuerpo Canaleta
PVC**



T-135-G PVC		55656		GRIS GREY	500X130	16	7,52
----------------	--	-------	--	--------------	---------	----	------

CUERPO CANALETA PVC

PVC CHANNEL BODY

Canaletas Garaje Serie Baja

Low series garage channels

Serie 500



REF.	SALIDA	CÓDIGO	APLICACIÓN	COLOR	MED./ÁNGULO	U/C	PVP €
REF.	OUTLET	CODE	APPLICATION	COLOUR	DIM./ANGLE	U/Box	€/pc
T-130-GB	Ø50-75	50151		GRIS GREY	 500X130X72	8	14,05
		50651		NEGRO BLACK		8	14,33

CANALETA CON REJILLA POLIPROPILENO

PP CHANNEL WITH GRID



T-131-GB	1	50168		GRIS GREY	90°	4	5,72
	2	50668		NEGRO BLACK		4	5,72

CONEXIÓN CANALETA 4 VÍAS POLIPROPILENO

PP 4-WAY CHANNEL CONNECTOR



T-133-GB	Ø75-50	50667		NEGRO BLACK	—	20	2,49
----------	--------	-------	--	----------------	---	----	------

COMPACTO SALIDA POLIPROPILENO

PP COMPACT OUTLET

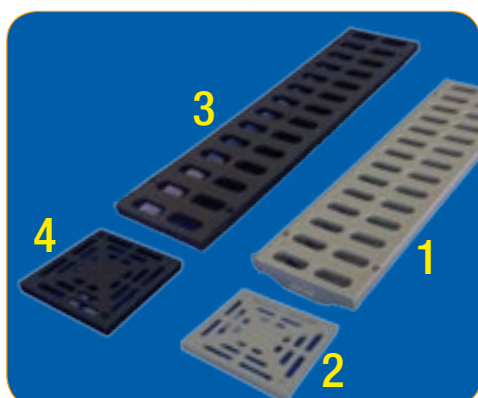

T-134-GB	1	50169		GRIS	500X130	20	7,52
T-132-GB	2	50165		GREY	130X130	20	3,24
T-134-GB	3	50669		NEGRO	500X130	20	7,52
T-132-GB	4	50565		BLACK	130X130	20	3,24

REJILLA POLIPROPILENO

PP GRID



T-135-GB	—	55151		GRIS GREY	500X130	28	5,73
		55651		NEGRO BLACK		28	5,73

CUERPO CANALETA POLIPROPILENO

PP CHANNEL BODY

Canaletas Piscina Serie Alta

High series swimming pool channels

Serie 500

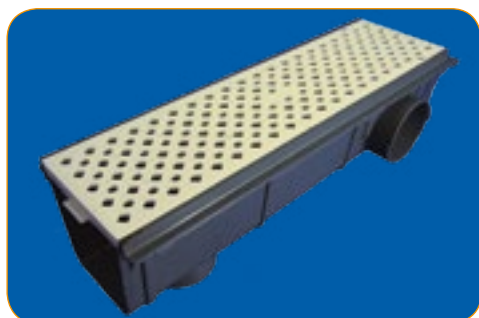

REF.	SALIDA	CÓDIGO	APLICACIÓN	COLOR	MED./ÁNGULO	U/C	PVP €
REF.	OUTLET	CODE	APPLICATION	COLOUR	DIM./ANGLE	U/Box	€/pc
T-130-P	Ø90	50663		REJILLA CREMA BEIGE GRID CANALETA GRIS GREY CHANNEL	 500X130X130	4	18,80
CANALETA CON REJILLA POLIPROPILENO PP CHANNEL WITH GRID							

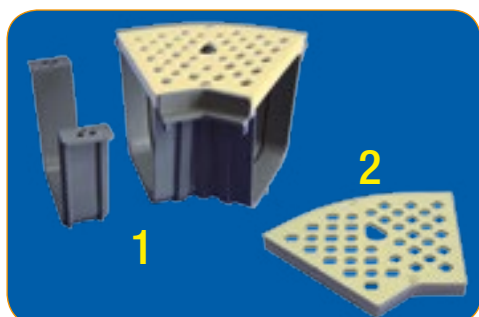

T-131-P	1	50664		REJILLA CREMA BEIGE GRID	45°	6	9,41
T-132-P	2	50661		CODO GRIS GREY ELBOW	45°	15	4,41
CODO CON REJILLA POLIPROPILENO / PP ELBOW WITH GRID REJILLA POLIPROPILENO / PP GRID							

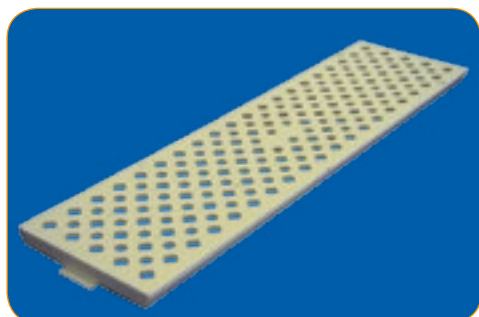

T-134-P	—	50662		CREMA BEIGE	500X130	20	8,77
REJILLA POLIPROPILENO PP GRID							



T-135-G	—	55656		PVC	500X130	16	7,52
CUERPO CANALETA PVC PVC CHANNEL BODY							

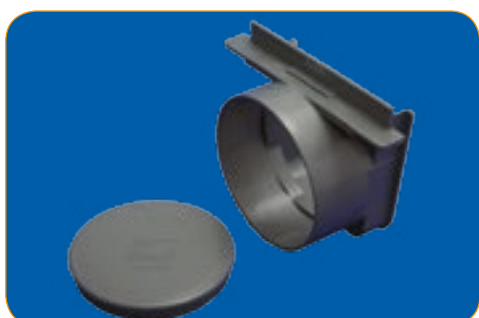

T-133-P	Ø110	50658		GRIS GREY	—	6	3,44
COMPACTO SALIDA CON TAPÓN COMPACT OUTLET WITH CAP							

Canaletas Piscina Serie Baja

Low series swimming pool channels

Serie 500

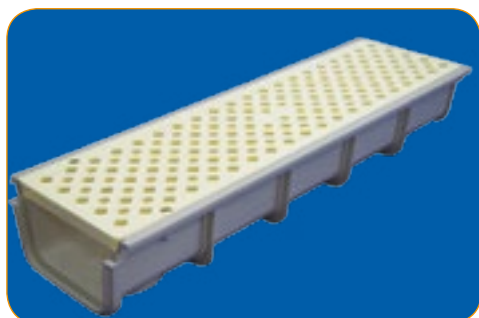

REF.	SALIDA	CÓDIGO	APLICACIÓN	COLOR	MED./ÁNGULO	U/C	PVP €
REF.	OUTLET	CODE	APPLICATION	COLOUR	DIM./ANGLE	U/Box	€/pc
T-130-PB	Ø50-75	50666		CREMA BEIGE	 500X130X72	8	14,33
CANALETA CON REJILLA POLIPROPILENO <i>PP CHANNEL WITH GRID</i>							



T-131-PB	—	50671		CREMA BEIGE	90°	4	5,72
CONEXIÓN CANALETA 4 VÍAS POLIPROPILENO <i>PP 4-WAY CHANNEL CONNECTOR</i>							

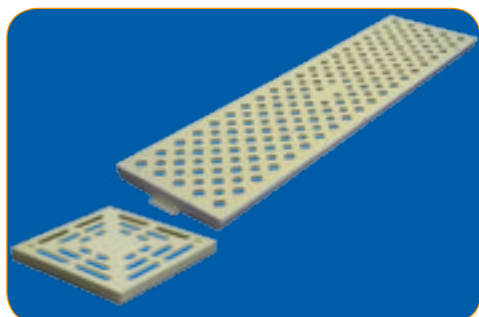

T-134-P	—	50662		CREMA BEIGE	500X130	20	8,77
T-132-PB	—	50673			130X130	20	3,24
REJILLA POLIPROPILENO / PP GRID REJILLA CONEXIÓN 4 VÍAS POLIPROPILENO / PP 4 WAY GRID CONNECTOR							



T-135-PB	—	55666		CREMA BEIGE	500X130	28	5,73
CUERPO CANALETA POLIPROPILENO <i>PP CHANNEL BODY</i>							

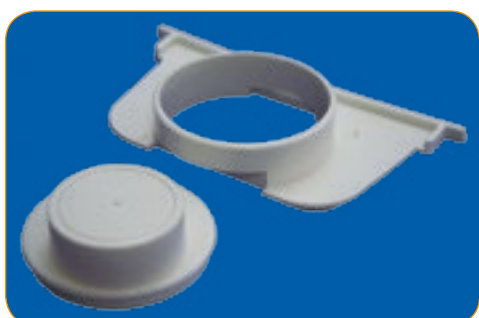

T-133-PB	Ø75-50	50603		CREMA BEIGE	500X130	20	2,49
COMPACTO SALIDA CON TAPÓN <i>COMPACT OUTLET WITH CAP</i>							



*Incorporamos CODIGO DE BARRAS
en toda la gama a partir de Ø50*



Accesorios

Evacuación

Sewage Accessories



CODOS
MACHO - HEMBRA

CÓDIGO	DIÁMETRO	U/C	PVP €
CODE	DIAMETER	U/Box	€/pc.
52010	Ø32	475	0,42
52011	Ø40	250	0,44
52012	Ø50	150	0,68
52013	Ø75	110	1,00
52014	Ø90	64	1,37
52015	Ø110	40	1,87
52016	Ø125	28	2,69
52017	Ø160	11	5,71
52018	Ø200	6	9,47
52019	Ø250	4	32,45
52120	Ø315	1	74,12

CODO MACHO - HEMBRA 87°
ELBOW 87° MALE-FEMALE

52206	Ø32	200	0,99
52207	Ø40	125	1,38
52208	Ø50	70	1,77
52217	Ø75	35	1,81
52218	Ø90	65	2,45
52219	Ø110	32	3,27
52220	Ø125	28	4,49
52221	Ø160	16	6,77
52122	Ø200	6	24,37

CODO MACHO - HEMBRA 67°
ELBOW 67° MALE-FEMALE

52030	Ø32	300	0,37
52031	Ø40	175	0,45
52032	Ø50	90	0,75
52033	Ø75	70	1,12
52034	Ø90	105	1,52
52035	Ø110	64	1,70
52036	Ø125	32	2,55
52037	Ø160	15	6,39
52038	Ø200	10	7,50
52039	Ø250	4	26,89
52040	Ø315	2	59,74

CODO MACHO-HEMBRA 45°
ELBOW 45° MALE-FEMALE

52113	Ø110	30	3,41
52114	Ø125	22	3,95

CODO MACHO-HEMBRA 22°
ELBOW 22° M-F

CODOS MACHO-HEMBRA CON INJERTOS



CÓDIGO	DIÁMETRO	U/C	PVP €
CODE	DIAMETER	U/Box	€/pc.
52190	Ø90-50	10	9,75
52191	Ø110-50	14	9,75
52192	Ø125-50	10	9,75

CODO MACHO-HEMBRA 87° CON 2 TOMAS *ELBOW 87° M-F 2 GRAFTS*



52830	Ø110-50	16	9,75
-------	---------	----	------

CODO MACHO-HEMBRA 67° CON 2 TOMAS *ELBOW 67° M-F 2 GRAFTS*



52810	Ø110-50	14	9,75
52825	Ø125-50	6	10,24

CODO MACHO-HEMBRA 45° CON 2 TOMAS *ELBOW 45° M-F 2 GRAFTS*



52110	Ø90-50	24	8,35
52111	Ø110-50	18	7,95

CODO M-H 87° CON TOMA POSTERIOR *ELBOW 87° M-F BACK GRAFT*

CODOS

HEMBRA - HEMBRA



52000	Ø32	475	0,36
52001	Ø40	250	0,42
52002	Ø50	150	0,62
52233	Ø75	20	3,12
52003	Ø90	28	2,49
52005	Ø110	32	2,16
52006	Ø125	24	3,65
52007	Ø160	11	13,65
52078	Ø200	6	15,82
52079	Ø250	1	91,28
52080	Ø315	1	141,66

CODO HEMBRA - HEMBRA 87° *ELBOW 87°, FEMALE - FEMALE*



52209	Ø32	200	0,54
52210	Ø40	125	0,55
52211	Ø50	70	0,85
52203	Ø125	28	7,95

CODO HEMBRA - HEMBRA 67° *ELBOW 67°, FEMALE - FEMALE*



H-H 45°

CÓDIGO	DIÁMETRO	U/C	PVP €
CODE	DIAMETER	U/Box	€/pc.
52020	Ø32	575	0,36
52021	Ø40	325	0,47
52022	Ø50	160	0,69
52023	Ø75	50	2,90
52024	Ø90	30	3,23
52025	Ø110	50	1,96
52026	Ø125	15	7,01
52027	Ø160	15	14,05
52028	Ø200	8	15,58
52029	Ø250	1	74,36
52130	Ø315	1	123,97

CODO HEMBRA - HEMBRA 45°

ELBOW 45°, FEMALE -FEMALE

CON 2 INJERTOS



H-H 87°

52008	Ø110-40	24	5,85
52009	Ø110-50	24	5,85
52125	Ø125-50	18	5,85

CODO HEMBRA-HEMBRA 87° CON 2 TOMAS

ELBOW 87° F- F 2 GRAFTS

DERIVACIONES

MACHO - HEMBRA



M-H 87°

52060	Ø32	100	0,96
52061	Ø40	70	0,88
52062	Ø50	40	1,29
52063	Ø75	40	1,56
52064	Ø90	48	2,14
52065	Ø110	23	2,57
52066	Ø125	22	3,97
52067	Ø160	8	10,23
52068	Ø200	6	26,69
52069	Ø250	2	51,06
52470	Ø315	1	134,65

DERIVACIÓN MACHO - HEMBRA 87°

T-BRANCH 87° MALE-FEMALE



M-H 67°

52234	Ø75	14	3,09
52235	Ø90	15	3,76
52236	Ø110	20	5,33
52237	Ø125	12	6,39
52238	Ø160	7	19,20

DERIVACIÓN MACHO - HEMBRA 67°

BRANCH 67° MALE-FEMALE



M-H 45°

CÓDIGO	DIÁMETRO	U/C	PVP €
CODE	DIAMETER	U/Box	€/pc.
52440	Ø32	15	0,95
52041	Ø40	20	1,15
52042	Ø50	10	1,55
52043	Ø75	65	1,74
52044	Ø90	36	2,81
52045	Ø110	24	3,11
52046	Ø125	16	5,03
52047	Ø160	6	11,53
52048	Ø200	3	28,25
52049	Ø250	1	66,44
52450	Ø315	1	137,84

DERIVACIÓN MACHO - HEMBRA 45°

BRANCH 45° MALE-FEMALE



M-H 45°

52214	Ø75	15	5,22
52215	Ø90	8	6,76
52216	Ø110	10	7,49
52231	Ø125	8	12,10
52256	Ø160	3	35,92

DERIV. DOBLE MACHO - HEMBRA 45°

PLAIN BRANCH 67° M-F



M-H 87°

52240	Ø90	12	5,39
52250	Ø110	6	6,95
52251	Ø125	10	10,16
52255	Ø160	6	36,70

DERIV. DOBLE MACHO - HEMBRA 87°

PLAIN T-BRANCH 87° M-F



M-H 87°

52710	Ø110	6	33,60
52725	Ø125	4	58,25

DERIV. DOBLE ESCUADRA MACHO-HEMBRA 87°

PLAIN BRANCH 87° M-F



M-H 67°

52595	Ø110	7	53,64
-------	------	---	-------

DERIV. DOBLE ESCUADRA MACHO-HEMBRA 67°

PLAIN BRANCH 67° M-F



M-H 45°

CÓDIGO	DIÁMETRO	U/C	PVP €
CODE	DIAMETER	U/Box	€/pc.
52590	Ø90	8	48,04
52510	Ø110	12	37,00
52525	Ø125	8	42,35

DERIV. DOBLE ESCUADRA MACHO-HEMBRA 45° CLAIN BRANCH 45° M-F

DERIVACIONES

HEMBRA - HEMBRA



H-H 87°

52070	Ø32	300	0,46
52071	Ø40	140	0,69
52072	Ø50	100	0,87
52372	Ø75	25	5,15
52472	Ø90	15	7,24
52073	Ø110	22	7,48
52074	Ø125	7	10,90
52075	Ø160	7	42,20
52077	Ø200	5	57,45
52088	Ø250	2	119,95
52089	Ø315	1	219,85

DERIVACIÓN HEMBRA - HEMBRA 87°

T-BRANCH 87°, F-F



H-H 67°

52228	Ø32	30	0,85
52229	Ø40	50	1,03
52230	Ø50	30	1,39

DERIVACIÓN HEMBRA - HEMBRA 67°

SIMPLE BRANCH 67° F-F



H-H 45°

52050	Ø32	250	0,55
52051	Ø40	120	0,78
52052	Ø50	80	0,93
52053	Ø75	24	5,79
52054	Ø90	10	8,49
52055	Ø110	15	10,08
52056	Ø125	5	11,64
52057	Ø160	3	22,93
52058	Ø200	3	38,99
52059	Ø250	1	119,95
52101	Ø315	1	219,85

DERIVACIÓN HEMBRA-HEMBRA 45°

BRANCH 45°, F-F



H-H 45°

CÓDIGO	DIÁMETRO	U/C	PVP €
CODE	DIAMETER	U/Box	€/pc.

52204	Ø40-40	4	2,30
DERIV. HEMBRA - HEMBRA 45° CLAIN BRANCH 45°, FEMALE - FEMALE			

Manguitos

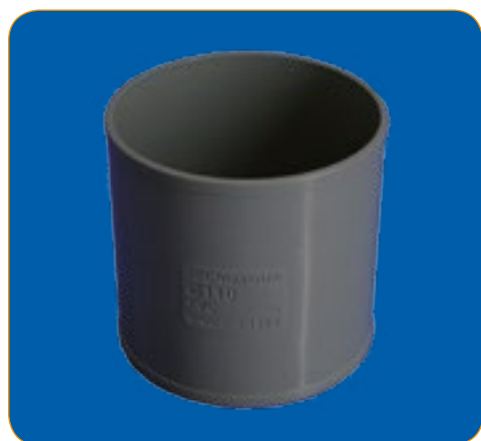

52132	Ø32	300	0,46
52133	Ø40	200	0,58
52134	Ø50	100	0,61
52135	Ø75	112	1,12
52136	Ø90	70	1,65
52137	Ø110	75	1,96
52138	Ø125	55	2,46
52139	Ø160	24	3,57
52131	Ø200	11	9,38
52198	Ø250	4	23,5
52199	Ø315	2	74,35
MANGUITO HEMBRA-HEMBRA		CONNECTOR, FEMALE - FEMALE	

Reducciones



50622	Ø40-32	70	0,40
50698	Ø50-32	30	0,80
50670	Ø50-40	30	0,60
CASQUILLO REDUCCIÓN MACHO-HEMBRA		REDUCING SOCKET	



52160	Ø125-40-40-40-50	62	1,70
TAPÓN MACHO REDUCIDO CUATRO TOMAS		REDUCER PLUG, M-F	



CÓDIGO	DIÁMETRO	U/C	PVP €
CODE	DIAMETER	U/Box	€/pc.

52354	Ø110-40-40-40	30	3,25
52159	Ø110-40-40-50	75	1,39

TAPÓN MACHO REDUCIDO TRES TOMAS *REDUCER PLUG, M-F*

52350	Ø90-32-32	20	1,10
52351	Ø90-32-40	20	1,10
52357	Ø110-40-32	10	2,95
52356	Ø110-40-40	30	2,95
52355	Ø110-50-40	30	2,95

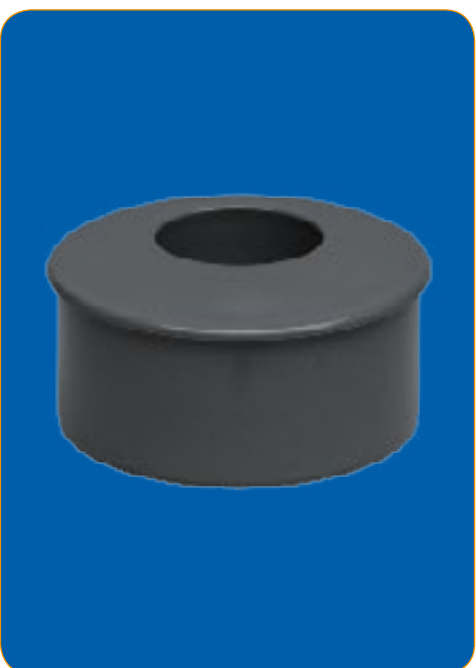
TAPÓN MACHO REDUCIDO DOS TOMAS *REDUCER PLUG, M-F*

52270	Ø75-32	40	2,21
52271	Ø75-40	40	2,21
52272	Ø75-50	40	2,34
52274	Ø90-40	60	2,42
52275	Ø90-50	60	2,55
52276	Ø90-75	60	2,55
52278	Ø110-40	30	3,06
52279	Ø110-50	30	3,06
52280	Ø110-75	30	3,19
52281	Ø110-90	30	3,19
52283	Ø125-32	27	3,27
52284	Ø125-40	27	3,27
52285	Ø125-50	27	3,27
52286	Ø125-75	27	3,32
52288	Ø125-110	27	3,32
52292	Ø160-125	15	6,16
52295	Ø200-125	8	10,84
52296	Ø200-160	8	10,84

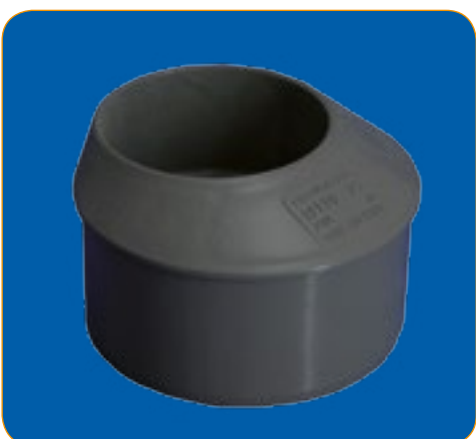
TAPÓN MACHO REDUCIDO UNA TOMA *REDUCER PLUG, M-F*

52140	Ø75-40	91	1,02
52141	Ø75-50	91	1,18
52142	Ø90-50	60	1,19
52143	Ø90-75	54	1,22
52144	Ø110-75	70	1,37
52145	Ø110-90	70	1,38
52146	Ø125-90	62	1,78
52147	Ø125-110	58	1,32
52148	Ø160-110	30	3,00
52149	Ø160-125	30	2,95
52150	Ø200-125	16	8,26
52181	Ø200-160	16	8,26

REDUCCIÓN EXCÉNTRICA M-H COMPRIMIDA *ECCENTRIC REDUCER, M-F*



CÓDIGO	DIÁMETRO	U/C	PVP €
CODE	DIAMETER	U/Box	€/pc.
52115	Ø40-32	70	0,95
52116	Ø50-32	50	0,95
52117	Ø50-40	40	0,98
52118	Ø125-50	15	3,15
52119	Ø125-110	36	5,27
52121	Ø160-110	20	6,15
52123	Ø160-125	21	6,30
52124	Ø200-125	10	9,03
52126	Ø200-160	10	9,80
52127	Ø250-200	6	20,95
52128	Ø315-200	2	68,25
52129	Ø315-250	4	38,59

REDUCCIÓN EXCÉNTRICA M-H *ECCENTRIC REDUCER, M-F*

Tapones Macho



52152	Ø40	100	0,37
52153	Ø50	30	0,48
52154	Ø75	98	0,68
52155	Ø90	72	0,89
52156	Ø110	75	1,05
52157	Ø125	62	1,38
52158	Ø160	30	4,11
52182	Ø200	17	6,21
52183	Ø250	4	14,28
52184	Ø315	5	56,65

TAPÓN MACHO *CAP, MALE*

Tapones Macho con Registro



52196	Ø32	50	1,78
52161	Ø40	35	1,07
52162	Ø50	25	1,51
52163	Ø75	25	2,43
52164	Ø90	20	3,18
52165	Ø110	30	3,35
52166	Ø125	24	3,67
52167	Ø160	12	7,52
52189	Ø200	13	19,83
52195	Ø250	4	40,07
52200	Ø315	4	142,98

TAPÓN FINAL CON REGISTRO *END CAP WITH REGISTRER*

Injertos



CÓDIGO	DIÁMETRO	U/C	PVP €
CODE	DIAMETER	U/Box	€/pc.

52168	Ø110-40	75	1,22
52169	Ø110-50	70	1,22
52170	Ø125-40	75	1,22
52171	Ø125-50	70	1,22

INJERTO CON ABRAZADERA ELÁSTICA *GRAFT WITH ELASTIC CLAMP*



52172	Ø90-40	33	1,42
52173	Ø90-50	33	1,42

INJERTO CON ABRAZADERA *GRAFT CLAMP*

Manguitos Reparación con Injerto

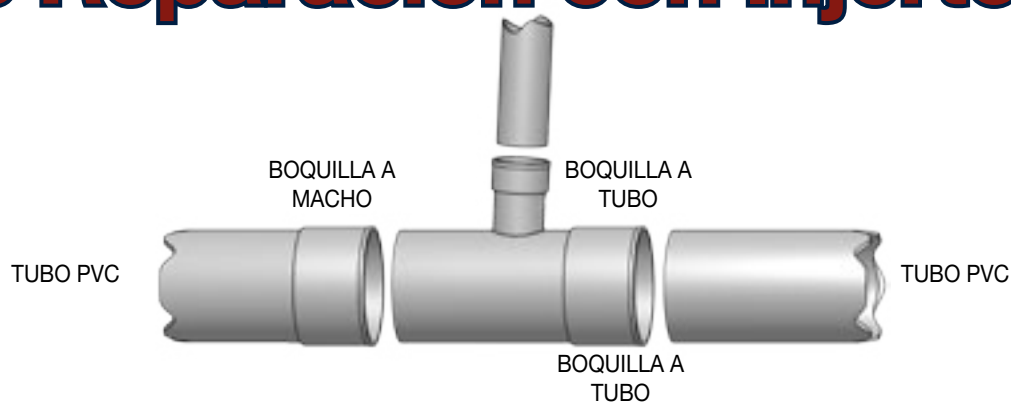

52103	Ø90-40	8	5,88
52104	Ø110-50	18	6,40
52105	Ø125-50	6	11,20

MANGUITO REPARADOR M-H UNA TOMA 87° *T-BRANCH 87° REDUCED M-F*

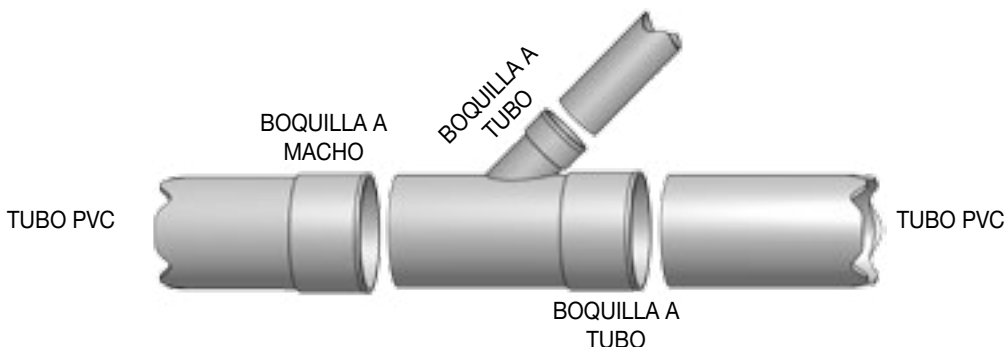

52102	Ø110-50	18	6,34
-------	---------	----	------

MANGUITO REPARADOR M-H UNA TOMA 45° *BRANCH 45° REDUCED M-F*

CÓDIGO	DIÁMETRO	U/C	PVP €
CODE	DIAMETER	U/Box	€/pc.

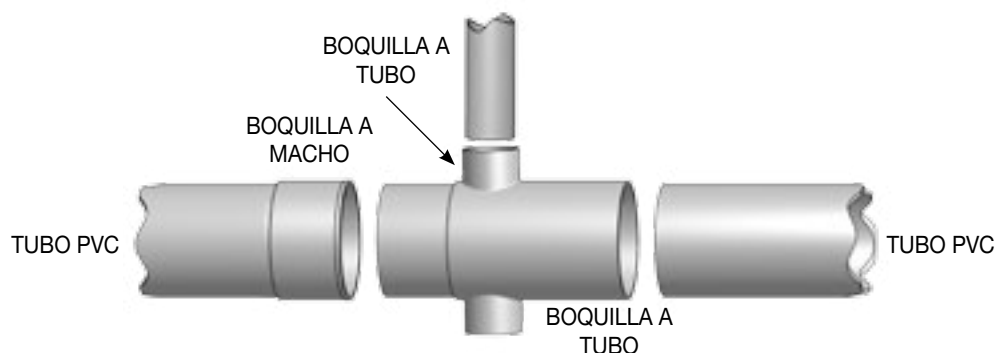

52106	Ø110-50	18	10,95
MANGUITO REPARADOR M-H DOS TOMAS 87°			BRANCH 87° REDUCED M-F

Manguitos Reparación



52185	Ø90	10	10,30
52186	Ø110	9	11,33
52187	Ø125	15	12,36
52188	Ø160	18	15,95

MANGUITO REPARADOR M-H

REPAIRING SLEEVE



52175	Ø90	10	7,50
52176	Ø110	6	5,45
52177	Ø125	18	8,55

MANGUITO REPARACIÓN A INTERIOR TUBO

REPAIRING SLEEVE

Manguitos de Reparación a Tubo Fibrocemento

CÓDIGO	DIÁMETRO	U/C	PVP €
CODE	DIAMETER	U/Box	€/pc.



BOQUILLA
TUBO PVC



TUBO
FIBROCEMENTO

52300	HEMBRA A FIBROCEMENTO Ø100	TUBO Ø 90 A BOQ.	10	7,57
52301	HEMBRA A FIBROCEMENTO Ø118	TUBO Ø110 A BOQ.	9	8,18
52302	HEMBRA A FIBROCEMENTO Ø143	TUBO Ø125 A BOQ.	6	8,65

MANGUITO CONVERSION FIBROCEMENTO A PVC



TUBO PVC

INJERTO A
INTERIOR
TUBO



TUBO
FIBROCEMENTO

52303	HEMBRA A FIBROCEMENTO Ø100	A INT. TUBO Ø 90	9	7,57
52304	HEMBRA A FIBROCEMENTO Ø118	A INT. TUBO Ø110	9	8,18
52305	HEMBRA A FIBROCEMENTO Ø143	A INT. TUBO Ø125	7	8,65

MANGUITO CONVERSION FIBROCEMENTO A PVC



TUBO
FIBROCEMENTO



TUBO PVC
Ø125

52306	HEMBRA PVC Ø125	A INT. TUBO FIBROCEMENTO Ø105	12	8,18
-------	-----------------	-------------------------------	----	------

MANGUITO CONVERSION PVC A FIBROCEMENTO



TUBO
MIXTO
(PVC Y FIBROCEMENTO)



TUBO PVC
Ø125

52308	HEMBRA PVC Ø125	A INT. TUBO MIXTO Ø95	15	8,18
-------	-----------------	-----------------------	----	------

MANGUITO CONVERSION PVC A MIXTO

NO ENCOLABLE



CÓDIGO	DIÁMETRO	U/C	PVP €
CODE	DIAMETER	U/Box	€/pc.

TUBO MIXTO
(PVC Y FIBROCEMENTO)



TUBO PVC
Ø110

52307	HEMBRA PVC Ø110	A INT. TUBO MIXTO Ø90	10	8.18
-------	-----------------	-----------------------	----	------

MANGUITO CONVERSOR PVC A MIXTO



TUBO PVC Ø75



TUBO PVC Ø90

52309	HEMBRA Ø90	A INT. TUBO Ø75	10	8,18
-------	------------	-----------------	----	------

MANGUITO CÓNICO

Sifón Registrable



52222	Ø110	3	46,35
52223	Ø125	2	56,65
52224	Ø160	2	66,95
52225	Ø200	1	118,45

SIFÓN CON REGISTRO MACHO-HEMBRA *V-TRAP WITH REGISTER, M-F*

Válvulas Antirretorno



52252	Ø110	2	190,55
52253	Ø125	2	200,85
52254	Ø160	2	303,85
52265	Ø200	2	365,65

VÁLVULA ANTIRETORNO

NON-RETURN VALVE



52532	Ø32	8	27,83
52540	Ø40	8	30,98
52550	Ø50	8	34,13

VALVULA ANTIRRETORNO ENCOLABLE

NON-RETURN VALVE

Sombreros Aireación

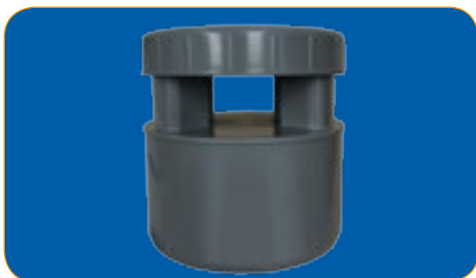

CÓDIGO	DIÁMETRO	U/C	PVP €
CODE	DIAMETER	U/Box	€/pc.

52640	Ø32-40-50	30	19,95
52610	Ø110	4	49,95

AIREADOR CON MEMBRANA

AIR SYSTEM



52932	Ø32	40	10,44
52940	Ø40	40	10,71
52950	Ø50	40	10,58
52975	Ø75	12	12,00
52990	Ø90	10	13,39
52991	Ø110	6	15,71
52992	Ø125	6	16,60
52996	Ø160	4	24,68
52998	Ø200	4	27,20

SOMBRERETE AIREACIÓN (COLOR PIZARRA) BLACK AERATURE HAT



Entronques Roscados



CÓDIGO	DIÁMETRO	U/C	PVP €
CODE	DIAMETER	U/Box	€/pc.

52870	Ø40-32mm-1/2	40	1,99
52871	Ø40-32mm-3/4	40	1,99

RACOR CALDERA ROSCA MACHO *HEATER MALE SOLVENT WELD COUPLING*

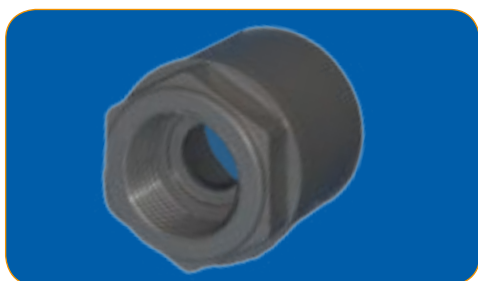

52872	Ø40-32mm-1/2	40	1,99
52873	Ø40-32mm-3/4	40	1,99

RACOR CALDERA ROSCA HEMBA *HEATER FEMALE SOLVENT WELD COUPLING*



Tecnoflex

Conexiones PVC flexibles



Encolable

REF.	SALIDA	CÓDIGO	APLICACIÓN	ALTURA	ENTRADA	U/C	PVP €
REF.	OUTLET	CODE	APPLICATION	HEIGHT	INLET	U/Box	€/pc
T-225	Ø32	50132		LONGITUD 240mm	Ø32	20	4,89
MANGUITO DUAL PVC FLEXIBLE Ø32 DUAL FLEXIBLE PVC HOSE							



Encolable

T-225	Ø40	50140		LONGITUD 270mm	Ø40	15	5,15
MANGUITO DUAL PVC FLEXIBLE Ø40 DUAL FLEXIBLE PVC HOSE							



Encolable

T-225	Ø50	50150		LONGITUD 300mm	Ø50	10	6,70
MANGUITO DUAL PVC FLEXIBLE Ø50 DUAL FLEXIBLE PVC HOSE							

Conexiones PVC Mixtas



REF.	SALIDA	CÓDIGO	GRÁFICA	U/C	PVP €
REF.	OUTLET	CODE		U/Box	€/pc
T-209-H	Ø40	50841		75	1,38
CONVERSOR EXTERIOR DE TUBO PVC A TUERCA LOCA EXTERNAL CONVERTER, FROM PVC PIPE TO SLIP NUT					



T-209-H	Ø40	50842		75	1,38
CONVERSOR EXTERIOR DE TUBO PVC A TUERCA LOCA EXTERNAL CONVERTER, FROM PVC PIPE TO SLIP NUT					



REF.	SALIDA	CÓDIGO	GRÁFICA	U/C	PVP €
REF.	OUTLET	CODE		U/Box	€/pc
T-209-M	Ø40	50848	<p>Junta Cónica Ø40</p>	75	1,38
CONVERSOR INTERIOR DE CODO HEMBRA PVC PARA RECIBIR TUBOS LISOS <i>INTERNAL FEMALE PVC ELBOW CONVERTER FOR SMOOTH PIPES</i>					



T-209-C	Ø40	50853	<p>Junta Cónica Ø40</p> <p>Hembra</p>	100	1,66
CONVERSOR EXTERIOR DE CODO MACHO PVC PARA RECIBIR TUBOS LISOS <i>EXTERNAL MALE PVC ELBOW CONVERTER FOR SMOOTH PIPES</i>					



T-217	Ø32	50850	<p>Junta Cónica Ø40</p>	60	1,66
T-217	Ø40	50855		60	1,66
CONVERSOR INTERIOR PARA TUBO DE PVC A TUBOS LISOS <i>INTERNAL CONVERTER FOR PVC TO SMOOTH PIPES</i>					



T-230	SALIDA Ø40	50710	<p>Junta Cónica Ø40</p>	25	1,84
	ENTRADA Ø28-35			25	
MANGUITO UNIÓN TUBO METÁLICO Ø28-35 A TUBO LISO Ø40 <i>UNION SMOOTH METAL TUBE TO TUBE</i>					



T-230	SALIDA Ø40	50711	<p>Junta Cónica Ø40</p>	25	1,84
	ENTRADA Ø38-40			25	
MANGUITO UNIÓN TUBO METÁLICO Ø38-40 A TUBO LISO Ø40 <i>UNION SMOOTH METAL TUBE TO TUBE</i>					



T-231	SALIDA Ø40 ENTRADA Ø28-32	50712	<p>Ø28-32</p> <p>Ø40</p>	30	1,55
T-231	SALIDA Ø50 ENTRADA Ø28-40	50713	<p>Ø28-40</p> <p>Ø50</p>	30	1,80
MANGUITO UNIÓN TUBO METÁLICO A TUBO PVC <i>UNION METAL TUBE SLEEVE F</i>					



REF.	SALIDA	CÓDIGO	GRÁFICA	U/C	PVP €
REF.	OUTLET	CODE		U/Box	€/pc
T-232	SALIDA Ø40 ENTRADA Ø28-32	50714	Ø28-32 Ø40 	30	1,55
T-232	SALIDA Ø50 ENTRADA Ø28-40	50715	Ø28-40 Ø50 	20	1,80

UNIÓN TUBO METÁLICO A CODO HEMBRA
UNION METAL TUBE SLEEVE M

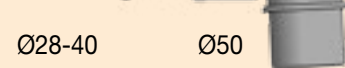

T-233	SALIDA Ø40 ENTRADA Ø28-32	50716	Ø28-32 Ø40 	30	1,55
T-233	SALIDA Ø50 ENTRADA Ø28-40	50717	Ø28-40 Ø50 	20	1,80

UNIÓN TUBO METÁLICO A CODO MACHO
UNION METAL TUBE SLEEVE M

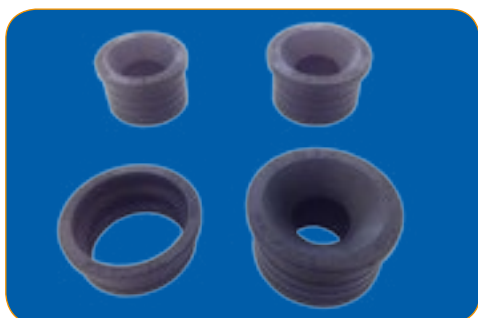

T-229	Ø28-35	50718	PARA T-230		30	1,29
	Ø38-40	50719	PARA T-230		60	1,29
	Ø28-32	50720	PARA T-231/T-232/T-233 Ø40		60	1,29
	Ø28-40	50721	PARA T-231/T-232/T-233 Ø50		30	1,29

JUNTA REPUESTO UNIÓN A TUBO METÁLICO
UNION BOARD REPLACEMENT METAL TUBE

Conexiones PVC con Toma de Lavadora

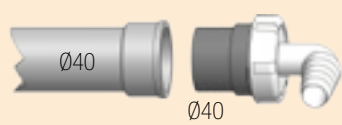

REF.	SALIDA	CÓDIGO	APLICACIÓN	ALTURA	ENTRADA	U/C	PVP €
REF.	OUTLET	CODE	APPLICATION	HEIGHT	INLET	U/Box	€/pc
T-210	Ø40	50849			Ø40	60	1,48

CONEXIÓN MACHO A HEMBRA CON TOMA LAVADORA 90°
PVC MALE CONNECTION WITH WASHING MACHINE CONNECTION

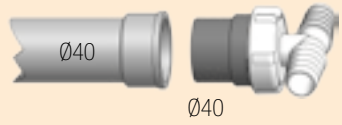

T-216	Ø40	50864			Ø40	60	2,24
-------	-----	-------	--	--	-----	----	------



CONEXIÓN MACHO A HEMBRA CON DOBLE TOMA LAVADORA 90°
PP CONNECTION WITH WASHING MACHINE CONNECTION



REF.	SALIDA	CÓDIGO	APLICACIÓN	ALTURA	ENTRADA	U/C	PVP €
REF.	OUTLET	CODE	APPLICATION	HEIGHT	INLET	U/Box	€/pc
T-219	Ø40	50804		60		60	2,24



CONEXIÓN MACHO A HEMBRA CON DOBLE TOMA LAVADORA 45°
PV DOUBLE CONNECTION WITH WASHING MACHINE



T-210I	Ø32	50748		20	1,78
T-210I	Ø40	50749		20	1,78



CONEXIÓN MACHO A INTERIOR TUBO CON TOMA LAVADORA 90°
PVC MALE CONNECTION WITH WASHING MACHINE CONNECTION



T-216I	Ø32	50763		20	2,54
T-216I	Ø40	50764		20	2,54

CONEXIÓN MACHO A INTERIOR TUBO CON DOBLE TOMA LAVADORA 90°
PVC CONNECTION WITH WASHING MACHINE CONNECTION



T-219I	Ø32	50783		20	2,54
T-219I	Ø40	50784		20	2,54

CONEXIÓN MACHO A INTERIOR TUBO CON DOBLE TOMA LAVADORA 45°
PVC DOUBLE CONNECTION WITH WASHING MACHINE

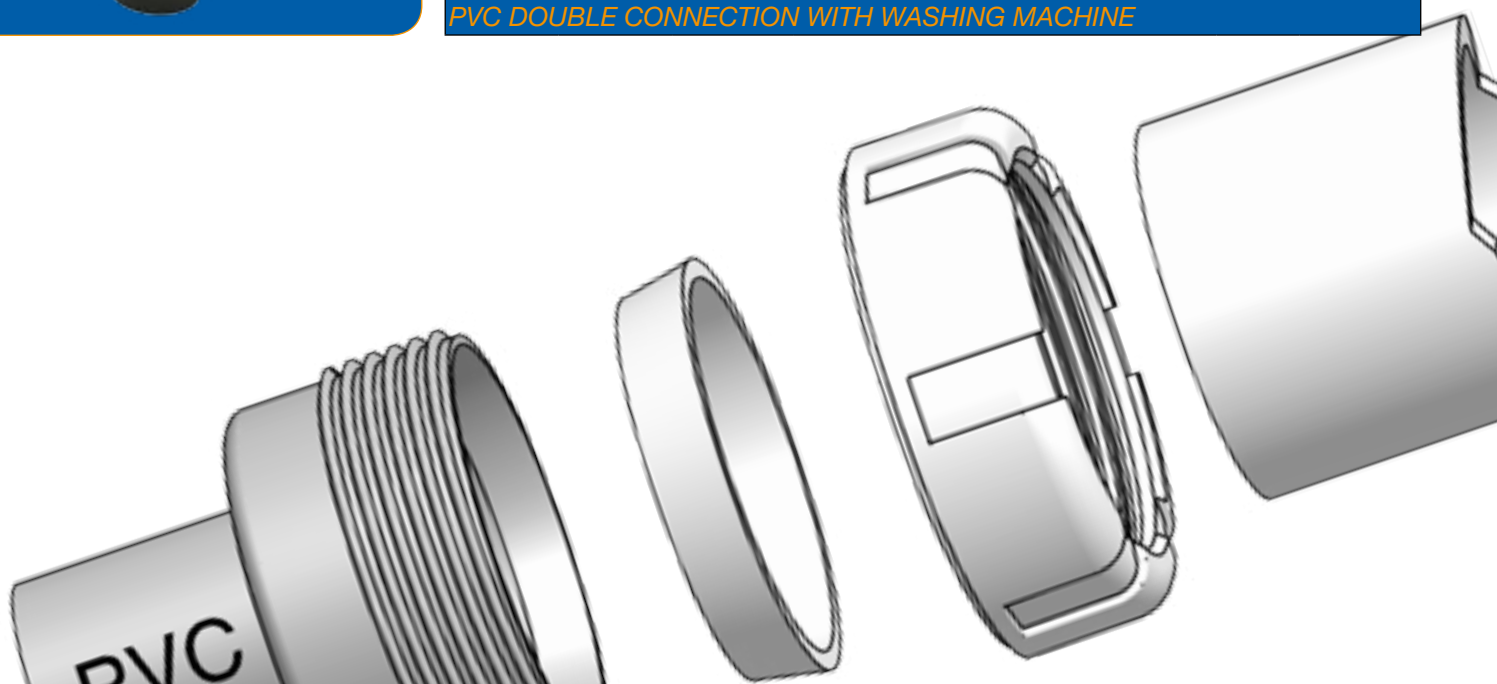



Fitting P.P.F.V. Collarines Válvulas esfera Fitting Latón

PP and brass fittings

Saddles



Cuerpo
polipropileno

Prensa Junta
polipropileno

Tuerca
polipropileno con fibra de vidrio



Junta Tórica
caucho

Casquillo Cónico
resina acetálica

MONTAJE RÁPIDO
Solamente precisa una ligera presión del tubo contra el accesorio, para obtener un montaje instantáneo.

FAST ASSEMBLY

To get an instant assembly you only need a slight pressure of the tube against the accessory.

Codificación con diferentes colores en función del diámetro



Grandes medidas reforzadas con casquillo metálico



CÓDIGO	DIÁMETRO	U/C	PVP €
CODE	DIAMETER	U/Box	€/pc.
28163	Ø63	18	15,38
28175	Ø75	9	23,42
28190	Ø90	6	34,94

ENLACE ROSCA HEMBRA
THREADED COUPLING, FEMALE



28663	Ø63	6	22,64
28775	Ø75	4	38,41
28990	Ø90	2	53,07

DERIVACIÓN T ROSCA HEMBRA
THREADED T-BRANCH COUPLING, FEMALE



28863	Ø63	9	14,22
28875	Ø75	6	27,57
28890	Ø90	3	47,07

CODO 90° ROSCA HEMBRA
THREADED ELBOW COUPLING 90°, FEMALE

Fitting P.P.F.V. con certificado AENOR

Fitting P.P.F.V. with AENOR certificate



CÓDIGO	DIÁMETRO		U/C	PVP €
CODE	DIAMETER		U/Box	€/pc.
20020	Ø20	1/2	80	1,40
20025	Ø25	3/4	50	1,63
20032	Ø32	1"	90	2,49
20040	Ø40	1¼	50	3,75
20050	Ø50	1½	35	6,05
20063	Ø63	2"	18	9,47
20075	Ø75	2½	9	16,12
20090	Ø90	3"	6	27,13

ENLACE ROSCA MACHO / *THREADED COUPLING, MALE*



20120	Ø20	1/2	80	1,73
20125	Ø25	3/4	50	2,06
20132	Ø32	1"	90	2,69
20140	Ø40	1¼	50	4,10
20150	Ø50	1½	35	6,41
20163	Ø63	2"	18	9,91
20175	Ø75	2½	9	18,02
20190	Ø90	3"	6	28,45

ENLACE ROSCA HEMBRA / *THREADED COUPLING, FEMALE*



20520	Ø20	Ø20	50	2,25
20525	Ø25	Ø25	90	2,73
20532	Ø32	Ø32	55	4,16
20540	Ø40	Ø40	30	6,06
20550	Ø50	Ø50	20	10,10
20563	Ø63	Ø63	8	15,52
20575	Ø75	Ø75	6	28,45
20590	Ø90	Ø90	4	47,37

ENLACE RECTO / *STRAIGHT COUPLING*



20625	Ø25	Ø20	30	2,73
20632	Ø32	Ø25	20	4,35
20640	Ø40	Ø32	12	5,62
20650	Ø50	Ø40	15	8,69
20663	Ø63	Ø50	10	13,95
20675	Ø75	Ø63	6	25,94
20690	Ø90	Ø75	4	39,67

ENLACE REDUCIDO / *REDUCED COUPLING*



20420	Ø20	Ø20	Ø20	75	3,43
20425	Ø25	Ø25	Ø25	50	4,17
20432	Ø32	Ø32	Ø32	30	5,97
20440	Ø40	Ø40	Ø40	18	9,14
20450	Ø50	Ø50	Ø50	12	14,93
20463	Ø63	Ø63	Ø63	4	23,51
20475	Ø75	Ø75	Ø75	3	40,42
20490	Ø90	Ø90	Ø90	2	60,01

T-3 BOCAS / *T - BRANCH COUPLING*



CÓDIGO	DIÁMETRO			U/C	PVP €
CODE	DIAMETER			U/Box	€/pc.
20725	Ø25	Ø20	Ø25	50	4,55
20732	Ø32	Ø25	Ø32	25	5,98
20740	Ø40	Ø32	Ø40	15	8,38
20750	Ø50	Ø40	Ø50	12	16,92
20763	Ø63	Ø50	Ø63	5	23,78

T-3 BOCAS REDUCIDA / REDUCED T - BRANCH COUPLING



22220	Ø20	Ø20	1/2	40	2,95
22225	Ø25	Ø25	3/4	80	3,66
22332	Ø32	Ø32	1"	40	5,11
22440	Ø40	Ø40	1¼	25	6,91
22550	Ø50	Ø50	1½	15	13,26
22663	Ø63	Ø63	2"	6	18,32
22775	Ø75	Ø75	2½	4	28,19
22890	Ø90	Ø90	3"	2	46,42

DERIVACION T ROSCA HEMBRA / THREADED T-BRANCH COUPLING, FEMALE



20320	Ø20	Ø20		45	2,37
20325	Ø25	Ø25		25	2,93
20332	Ø32	Ø32		45	4,25
20340	Ø40	Ø40		25	6,55
20350	Ø50	Ø50		5	10,63
20363	Ø63	Ø63		6	16,60
20375	Ø75	Ø75		4	28,32
20390	Ø90	Ø90		3	47,13

CODO 90° / ELBOW COUPLING 90°



20920	Ø20	1/2	70	2,04
20925	Ø25	3/4	40	2,52
20932	Ø32	1"	20	3,81
20940	Ø40	1¼	40	4,54
20950	Ø50	1½	7	7,79
20963	Ø63	2"	9	9,94

CODO 90° ROSCA MACHO / THREADED ELBOW COUPLING 90°, MALE



20820	Ø20	1/2	70	2,55
20825	Ø25	3/4	40	2,81
20832	Ø32	1"	20	3,79
20840	Ø40	1¼	40	5,01
20850	Ø50	1½	7	8,57
20863	Ø63	2"	9	10,92
20875	Ø75	2½	6	22,17
20890	Ø90	3"	3	42,98

CODO 90° ROSCA HEMBRA / THREADED ELBOW COUPLING 90°, FEMALE



23325	Ø25	1/2	Ø25	25	3,22
23332	Ø32	3/4	Ø32	45	4,67

CODO 90° ROSCA LATERAL HEMBRA / THREADED ELBOW COUPLING 90°, FEMALE

Codo 90° Especial Jardinería



CÓDIGO	DIÁMETRO	U/C	PVP €
CODE	DIAMETER	U/Box	€/pc.
20220	Ø20	100	1,78
20225	Ø25	60	2,11
20232	Ø32	30	3,22
20240	Ø40	15	3,95
20250	Ø50	12	6,28
20263	Ø63	18	9,68
20275	Ø75	9	25,57
20290	Ø90	6	32,16

TAPON FINAL / END CAP



80000	Ø20	1/2	25	3,46
80001	Ø25	3/4	25	4,20
80002	Ø32	1	15	5,96

PLACA GRIFO / WALL COUPLING

Collarines con refuerzo Inox

Clamp with stainless steel reinforcement



2 Tornillos

21501	25	1/2	45	2,01
21502	25	3/4	45	2,01
21503	32	1/2	40	2,54
21504	32	3/4	30	2,54
21505	32	1"	30	2,54
21506	40	1/2	25	3,04
21507	40	3/4	25	3,04
21508	40	1"	25	3,04
21509	50	1/2	15	3,61
21510	50	3/4	15	3,61
21511	50	1"	15	3,61



4 Tornillos

21512	63	1/2	15	5,22
21513	63	3/4	15	5,22
21514	63	1"	15	5,22
21515	63	1¼	15	5,22
21516	63	1½	15	5,22
21517	75	1/2	10	6,49
21518	75	3/4	10	6,49
21519	75	1"	10	6,49
21520	75	1¼	8	6,49
21521	75	1½	8	6,49
21522	75	2"	8	6,49
21523	90	1/2	8	8,01
21524	90	3/4	6	8,01
21525	90	1"	6	8,01
21526	90	1¼	6	8,01
21527	90	1½	6	8,01
21528	90	2"	5	8,01

COLLARINES / CLAMP

VÁLVULAS ESFERA PVC PRESIÓN ENCOLAR



CÓDIGO	DIÁMETRO	U/C	PVP €
CODE	DIAMETER	U/Box	€/pc.
29120	Ø20	18	11,46
29125	Ø25	8	15,29
29132	Ø32	6	16,26
29140	Ø40	12	22,96
29150	Ø50	9	24,49
29163	Ø63	6	36,34
29175	Ø75	3	155,60
29190	Ø90	3	197,93
29191	Ø110	2	202,92

VÁLVULA ESFERA PVC PRESIÓN ENCOLAR
 COMPRESSION FITTING BALL VALVE

VÁLVULAS ESFERA PVC PRESIÓN ROSCAR



CÓDIGO	DIÁMETRO	U/C	PVP €
CODE	DIAMETER	U/Box	€/pc.
29220	Ø20 - 1/2"	18	12,63
29225	Ø25 - 3/4"	8	16,43
29232	Ø32 - 1"	6	18,18
29240	Ø40 - 1 1/4"	12	24,87
29250	Ø50 - 1 1/2"	9	26,79
29263	Ø63 - 2"	6	39,37
29275	Ø75 - 2 1/2"	3	164,45
29290	Ø90 - 3"	3	208,64
29291	Ø110 - 4"	2	240,46

VÁLVULA ESFERA PVC PRESIÓN ROSCAR
 THREADED BALL VALVE

VÁLVULAS ESFERA PP PARA TUBO DE POLIETILENO



CÓDIGO	DIÁMETRO	U/C	PVP €
CODE	DIAMETER	U/Box	€/pc.
29020	Ø20	20	14,78
29025	Ø25	9	19,70
29032	Ø32	7	26,59
29040	Ø40	3	31,52
29050	Ø50	3	40,32
29063	Ø63	1	52,23

VÁLVULA ESFERA POLIPROPILENO PARA TUBO DE POLIETILENO
COMPRESSION FITTING BALL VALVE



Fitting Latón

Brass fitting

- Debido a la fluctuación del precio de las materias primas, el precio del fitting del latón se podrá modificar sin previo aviso.
- *Due to the unstable level of the raw material prices, the brass fitting prices can be modified without any prior notice.*



CÓDIGO	DIÁMETRO		U/C	PVP €
CODE	DIAMETER		U/Box	€/pc.
30020	Ø20	1/2	100	3,82
30025	Ø25	3/4	70	5,84
30032	Ø32	1"	40	8,66
30040	Ø40	1¼	20	14,33
30050	Ø50	1½	15	22,19
30063	Ø63	2"	8	34,03

ENLACE ROSCA MACHO / *THREADED COUPLING, MALE*



30120	Ø20	1/2	100	4,06
30125	Ø25	3/4	60	6,43
30132	Ø32	1"	40	8,88
30140	Ø40	1¼	20	17,49
30150	Ø50	1½	15	27,37
30163	Ø63	2"	8	38,86

ENLACE ROSCA HEMBRA / *THREADED COUPLING, FEMALE*



30520	Ø20	Ø20	70	5,90
30525	Ø25	Ø25	30	9,75
30532	Ø32	Ø32	25	13,01
30540	Ø40	Ø40	18	23,06
30550	Ø50	Ø50	8	36,68
30563	Ø63	Ø63	5	56,12

ENLACE RECTO / *STRAIGHT COUPLING*



30420	Ø20	Ø20	Ø20	40	10,36
30425	Ø25	Ø25	Ø25	20	16,83
30432	Ø32	Ø32	Ø32	15	23,11
30440	Ø40	Ø40	Ø40	6	39,43
30450	Ø50	Ø50	Ø50	3	62,99
30463	Ø63	Ø63	Ø63	2	99,56

T-3 BOCAS / *T-BRANCH COUPLING*



30220	Ø20	Ø20	1/2	40	7,97
30225	Ø25	Ø25	3/4	30	13,23
30232	Ø32	Ø32	1"	15	18,60
30240	Ø40	Ø40	1¼	8	32,45
30250	Ø50	Ø50	1½	5	53,19
30263	Ø63	Ø63	2"	3	85,44

DERIVACIÓN T ROSCA HEMBRA / *THREADED T-BRANCH COUPLING, FEMALE*



CÓDIGO	DIÁMETRO		U/C	PVP €
CODE	DIAMETER		U/Box	€/pc.
30320	Ø20	Ø20	60	7,29
30325	Ø25	Ø25	30	11,93
30332	Ø32	Ø32	20	16,28
30340	Ø40	Ø40	10	29,41
30350	Ø50	Ø50	5	44,56
30363	Ø63	Ø63	3	71,69

CODO 90° / *ELBOW COUPLING 90°*



30920	Ø20	1/2	80	5,33
30925	Ø25	3/4	40	8,07
30932	Ø32	1"	30	11,54
30940	Ø40	1¼	20	20,01
30950	Ø50	1½	9	29,79
30963	Ø63	2"	5	49,92

CODO 90° ROSCA MACHO / *THREADED ELBOW COUPLING 90°, MALE*



30820	Ø20	1/2	80	5,37
30825	Ø25	3/4	40	8,54
30832	Ø32	1"	25	12,55
30840	Ø40	1¼	18	21,60
30850	Ø50	1½	9	33,44
30863	Ø63	2"	5	54,50

CODO 90° ROSCA HEMBRA / *THREADED ELBOW COUPLING 90°, FEMALE*



30620	Ø20	1/2	50	7,33
30625	Ø25	3/4	30	11,19
30632	Ø32	1"	25	15,47

PLACA GRIFO / *WALL COUPLING*



Fitting Latón *Grandes Medidas*

Brass fitting *big sizes*



CÓDIGO	DIÁMETRO		U/C	PVP €
CODE	DIAMETER		U/Box	€/pc.
30075	Ø75	2½	8	58,23
30090	Ø90	3"	3	86,21
ENLACE ROSCA MACHO				
THREADED CONNECTOR, MALE				



30175	Ø75	2½	8	60,67
30190	Ø90	3"	3	91,43
ENLACE ROSCA HEMBRA				
THREADED CONNECTOR, FEMALE				



30575	Ø75		4	99,62
30590	Ø90		3	152,99
ENLACE RECTO				
STRAIGHT CONNECTOR				



30975	Ø75	2½	3	80,84
30990	Ø90	3"	2	134,82
CODO 90° ROSCA MACHO				
THREADED ELBOW CONNECTOR 90°, MALE				



30375	Ø75		2	127,02
30390	Ø90		1	208,48
CODO 90°				
ELBOW CONNECTOR 90°				



CÓDIGO	MEDIDA		U/C	P.V.P. €
30875	Ø75	2½	3	78,54
30890	Ø90	3"	2	130,31

CODO 90° ROSCA HEMBRA
THREADED ELBOW CONNECTOR 90°, FEMALE



30275	Ø75	2½	1	137,88
30290	Ø90	3"	1	214,61

DERIVACIÓN T ROSCA HEMBRA
THREADED T-BRANCH CONNECTOR, FEMALE



30475	Ø75	1	187,77
30490	Ø90	1	297,39

T 3 BOCAS
T-BRANCH CONNECTOR





Recambios

Índice de códigos

Spare parts

Code index





REF.	SALIDA	CÓDIGO	APLICACIÓN	COTAS	ENTRADA	U/C	P.V.P. €
REF.	OUTLET	CODE	APPLICATION	DIMENSIONS	INLET	U/Box	€/pc
T-500	—	50900		—	1½	50	0,83
T-500-A	—	50901		—	1½	S/P	0,92

TAPÓN FREGADERO

SINK PLUG WITH HANDLE



T-93	1½	50350		—	Ø115	25	3,76
T-93	1½	50351		—	Ø85	25	3,76

TAPÓN VÁLVULA CESTA INOX SERIE HONDA

STAINLESS STEEL BASKET VALVE PLUG DEEP SERIES

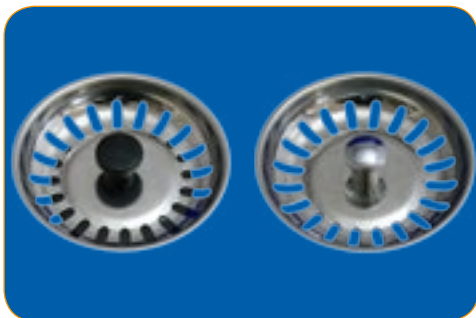

T-93-BP	1½	50358		—	Ø115	25	3,76
T-93-BM	1½	50359		—	Ø115	25	4,08

TAPÓN VÁLVULA CESTA INOX SERIE BAJA

STAINLESS STEEL BASKET VALVE PLUG LOW SERIES



T-92	1½	50349		Ø115	BLANCO	25	2,81
T-92	1½	50379		Ø115	MARRÓN	25	2,81
T-92	1½	50389		Ø115	TERRA FRANCE	25	2,81

TAPÓN COLOR RECAMBIO

SPARE COLOUR PLUG



T-94	—	50902		—	1½	S/P	4,64
------	---	-------	--	---	----	-----	------

TAPÓN T-64 A VÁLVULA AUTOMÁTICA

PLUG FOR AUTOMATIC VALVE T-64 A



T-578T	—	50239	T-78T	—	Ø115	S/P	10,71
T-578B	—	50233	T-78B	—	Ø115	S/P	10,71
T-578	—	50234	T-78	—	Ø115	S/P	10,71
T-577	—	50235	T-77	—	Ø90	S/P	10,71

EMBELLECEDOR VÁLVULA PLATO DE DUCHA

LUXURY COVER



REF.	SALIDA	CÓDIGO	APLICACIÓN	COTAS	ENTRADA	U/C	P.V.P. €
REF.	OUTLET	CODE	APPLICATION	DIMENSIONS	INLET	U/Box	€/pc
T-501	—	50905		270	1½	S/P	2,70
T-501	—	50906		380	1½	S/P	4,18

TAPÓN CON CADENA
PLUG WITH CHAIN



T-502	—	50910		Ø65		S/P	1,02
T-502	—	50911		Ø70			1,02
T-502	—	50912		Ø85		S/P	1,72
T-502	—	50913		Ø115			2,55

REJILLA INOX
STAINLESS STEEL GRATING



T-503	—	50915		—	1½	S/P	1,15
-------	---	-------	--	---	----	-----	------

TAPA REBOSADERO BAÑERA INOX
STAINLESS STEEL BATHTUB OVERFLOW COVER



T-504	—	50920		Ø110	—	S/P	2,19
-------	---	-------	--	------	---	-----	------

EMBELLECEDOR BOTE SIFÓNICO
FLOOR TRAP COVER



T-504-S	—	50921		Ø110	—	S/P	2,38
---------	---	-------	--	------	---	-----	------

EMBELLECEDOR BOTE SIFÓNICO
FLOOR TRAP GRATED COVER



T-510	—	50652		10X10	—	20	3,62
T-510	—	50654		15X15	—	S/P	7,99
T-510	—	50653		20X20	—	S/P	13,40

REJILLA INOX
STAINLESS STEEL GRATING



REF.	SALIDA	CÓDIGO	APLICACIÓN	COTAS	ENTRADA	U/C	P.V.P. €
REF.	OUTLET	CODE	APPLICATION	DIMENSIONS	INLET	U/Box	€/pc
T-520L	—	50563	SUMIDEROS 10X10		—	20	10,71

REJILLA LUJO INOX
STAINLESS STEEL GRATING



T-511L	—	50655	SUMIDEROS 10X10		—	20	4,28
--------	---	-------	-----------------	--	---	----	------

REJILLA LUJO ABS
STAINLESS STEEL GRATING



T-520D	—	50577	SUMIDEROS 10X10		—	20	6,43
--------	---	-------	-----------------	--	---	----	------

REJILLA DIAGONAL INOX
STAINLESS STEEL GRATING



T-520N	—	50578	SUMIDEROS 10X10		—	20	8,57
--------	---	-------	-----------------	--	---	----	------

REJILLA LINEAL INOX
STAINLESS STEEL GRATING

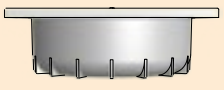

T-84	Ø90-Ø110	50360	SUMIDEROS		25X25	6	4,50
T-84	Ø50	50361			20X20		
T-84	Ø40	50362			15X15		
					10X10	12	1,69

CODO 360° AHORRO ESPACIO SUMIDEROS
ELBOW 360°



T-88-R	—	50645		—	30x30	S/P	11,97
T-88-R	—	50646		—	25X25		7,79
T-88-R	—	50647		—	20X20		5,97
T-88-R	—	50648		—	15X15		4,93

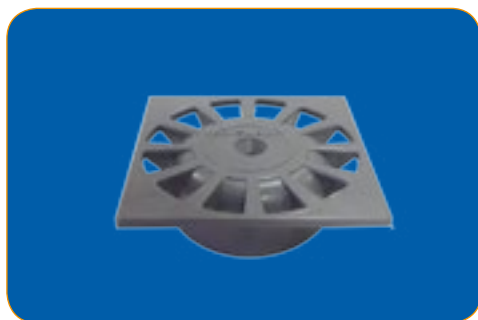

REJILLA SUMIDERO SIFÓNICO PVC
PVC FLOOR DRAIN GRATING



REF.	SALIDA	CÓDIGO	APLICACIÓN	COTAS	ENTRADA	U/C	P.V.P. €
REF.	OUTLET	CODE	APPLICATION	DIMENSIONS	INLET	U/Box	€/pc
T-88 R	—	50649	PARA SUMIDERO T-88 10X10		—	S/P	3,32
T-87 R	—	50949	PARA SUMIDERO T-87 10X10		—	S/P	3,32







REJILLA SUMIDERO SIFÓNICO PVC
PVC FLOOR DRAIN GRATING



T-503	1½	50031		—		S/P	8,12
-------	----	-------	--	---	---	-----	------





PLAFÓN REBOSADERO PARA T-64 A
OVERFLOW CAP FOR T-64 A

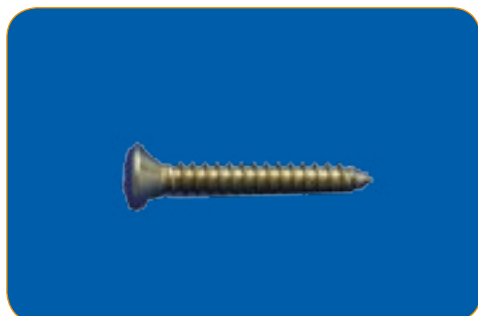

T-505	—	50925		6 X 20	—	S/P	0,27
		50926		6 X 35			0,39
		50928		6 X 45			0,46
		50929		6 X 55			0,56
		50927		6 X 65			0,60
		50932		6 X 75			0,81

TORNILLO GOTA DE SEBO
LONG SCREW



T-505 R	—	50941		3,5X19	—	S/P	0,19
		50942		3,5X25			0,16
		50944		4,8X25			0,25
		50945		4,8X32			0,26

TORNILLO ROSCA CHAPA
SHORT SCREW



T-506	—	50930		270	—	S/P	1,12
T-506	—	50931		380	—	S/P	1,66

CADENA DE BOLAS
BALL CHAIN



T-516	—	50948		—	Ø70	S/P	1,41
T-516	—	50946		—	Ø85	S/P	1,41
T-516	—	50947		—	Ø115	S/P	2,03

REJILLA INOX. VÁLVULAS PLATO DUCHA
STAINLESS STEEL GRATING FOR SHOWER TRAY VALVES



REF.	SALIDA	CÓDIGO	APLICACIÓN	COTAS	ENTRADA	U/C	P.V.P. €
REF.	OUTLET	CODE	APPLICATION	DIMENSIONS	INLET	U/Box	€/pc
T-539	1½	50977	CIERRES SHUTTER	PARA T-39 D	1¼	100	0,95

JUNTA PLANA CONVERTOR 1½ A 1¼

PLAIN GASKET 1½ TO 1¼ CONVERTOR



T-507	—	50935	CIERRES SHUTTER	—	1	100	0,20
T-507	—	50936		—	1¼		0,21
T-507	—	50937		—	1½		0,23

JUNTA CÓNICA

CONICAL GASKET



T-508	—	50940	CIERRES SHUTTER	—	1½ 1¼	100	0,25
-------	---	-------	--------------------	---	----------	-----	------

JUNTA CÓNICA REDUCIDA

REDUCED CONICAL GASKET



T-509	—	50950	CIERRES SHUTTER	—	1¼	100	0,20
T-509	—	50951	CIERRES SHUTTER	—	1½	100	0,20

JUNTA RACORD

CONNECTION GASKET



T-512	—	50953	CIERRES SHUTTER	—	Ø65	100	0,18
T-512	—	50954		—	Ø70		0,18
T-512	—	50955		—	Ø85		0,23
T-512	—	50956		—	Ø115		0,26

JUNTA PLANA

PLAIN GASKET



T-513	—	50960	VARIOS VARIOUS	—	Ø70	100	0,52
T-513	—	50961		—	Ø85		0,52
T-513	—	50962		—	Ø90		0,52
T-513	—	50963		—	Ø115	20	0,64

JUNTA BASE LABIADA

LABIATE BASE RING



REF.	SALIDA	CÓDIGO	APLICACIÓN	COTAS	ENTRADA	U/C	P.V.P. €
REF.	OUTLET	CODE	APPLICATION	DIMENSIONS	INLET	U/Box	€/pc
T-518	1	50989	SIFONES	—	1	S/P	0,60
T-518	1¼	50968		—	1¼		0,69
T-518	1½	50967		—	1½		0,82

TUERCA SERIE BLANCA

WHITE SEREIS NUT



T-519	1	50999	SIFONES	—	1	S/P	2,38
T-519	1¼	50998		—	1¼		2,67
T-519	1½	50997		—	1½		3,25

TUERCA SERIE METALIZADOS

METALLIZED SERIES NUT



T-339	1½	50978	PARA T-39 D	1¼	50	5,25
-------	----	-------	-------------	----	----	------

KIT CONVERSION 1½ A 1¼

1½ TO 1¼ CONVERSION KIT



T-439	1½	50979	PARA T-39 D ME	1¼	50	5,25
-------	----	-------	----------------	----	----	------

KIT CONVERSION 1½ A 1¼ SERIE METALIZADOS

METALLIZED SERIES 1½ TO 1¼ CONVERSION KIT



T-303 R	Ø70	50302	PARA T-303 TECNO CLICK CLACK	Ø70	S/P	5,25
---------	-----	-------	------------------------------------	-----	-----	------

PLAFÓN EMBELLECEDOR VÁLVULA TECNO CLICK CLACK

METALLIZED GRID VALVE SPARE



T-105	—	50105	CIERRES SHUTTER	—	—	S/P	0,95
-------	---	-------	--------------------	---	---	-----	------

MEMBRANA CIERRE CLICK-CLACK

CLICK-CLACK MEMBRANE SHUTTER



REF.	SALIDA	CÓDIGO	APLICACIÓN	COTAS	ENTRADA	U/C	P.V.P. €
REF.	OUTLET	CODE	APPLICATION	DIMENSIONS	INLET	U/Box	€/pc
T-505 C	CROMO	50430		6 X 65		S/P	1,52
T-505 O	ORO	50431		6 X 65			2,08
T-505BL	BLANCO	50432		6 X 65			1,35

TORNILLO LUJO
LUXURY SCREW



T-506-C	CROMO	50437		270		S/P	5,11
T-506-O	ORO	50433		270			5,11
T-506-BL	BLANCO	50434		270			3,71
T-506-O	ORO	50435		420			7,66
T-506-BL	BLANCO	50436		420			7,89

CADENA DE BOLAS LUJO
LUXURY BALL CHAIN

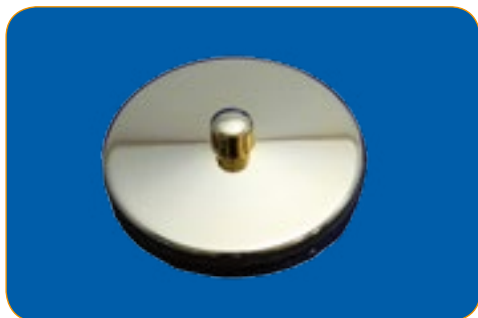

T-500 C	CROMO	50415		1½	—	S/P	6,10
T-500 O	ORO	50416		1½	—		8,64
T-500BL	BLANCO	50417		1½	—		7,47

TAPÓN SERIE LUJO CON JUNTA TÓRICA
LUXURY SERIES PLUG WITH O-RING



T-502 C	CROMO CHROME	50418		1½	—	S/P	2,76
T-502 O	ORO GOLD	50419		1½	—		6,68
T-502BL	BLANCO WHITE	50420		1½	—		4,45

REJILLA VÁLVULA LUJO
LUXURY VALVE GRATING



T-503-C	CROMO CHROME	50421		1½	—	S/P	2,27
T-503-O	ORO GOLD	50422		1½	—		6,68
T-503BL	BLANCO WHITE	50439		1½	—		4,45

TAPA REBOSADERO LUJO
LUXURY OVERFLOW COVER

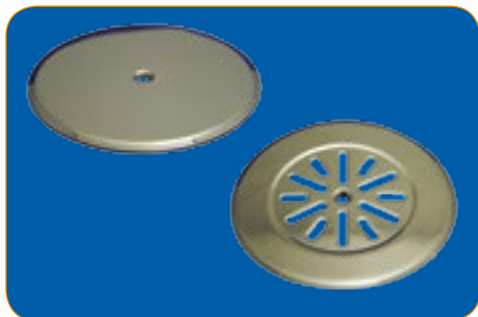

T-504-L	ORO GOLD	50424		Ø110	—	S/P	14,16
T-504-SL	ORO GOLD	50425		Ø110	—	S/P	14,16

EMBELLECEDOR BOTE LUJO
LUXURY COVER FOR FLOOR TRAP



REF.	SALIDA	CÓDIGO	APLICACIÓN	COTAS	ENTRADA	U/C	P.V.P. €
REF.	OUTLET	CODE	APPLICATION	DIMENSIONS	INLET	U/Box	€/pc
T-515	—	50938			Ø115	S/P	0,85
T-515	—	50939			Ø85	S/P	0,65

JUNTA PLANA PLATO DE DUCHA
PLAIN GASKET

RECAMBIOS PARA FITTING P.P.F.V.



T-814	Ø20	25120	CIERRES SHUTTER	—	Ø20	S/P	0,41
T-814	Ø25	25125			Ø25	S/P	0,46
T-814	Ø32	25132			Ø32	S/P	0,76
T-814	Ø40	25140			Ø40	S/P	1,01
T-814	Ø50	25150			Ø50	S/P	2,11
T-814	Ø63	25163			Ø63	S/P	3,51
T-814	Ø75	25175			Ø75	S/P	5,88
T-814	Ø90	25190			Ø90	S/P	9,55

TUERCA FITTING



T-714	Ø20	25220	CIERRES SHUTTER	—	Ø20	S/P	0,11
T-714	Ø25	25225			Ø25	S/P	0,15
T-714	Ø32	25232			Ø32	S/P	0,27
T-714	Ø40	25240			Ø40	S/P	0,36
T-714	Ø50	25250			Ø50	S/P	0,90
T-714	Ø63	25263			Ø63	S/P	1,11
T-714	Ø75	25275			Ø75	S/P	1,83
T-714	Ø90	25290			Ø90	S/P	2,38

CASQUILLO CÓNICO FITTING



T-614	Ø20	25320	CIERRES SHUTTER	—	Ø20	S/P	0,05
T-614	Ø25	25325			Ø25	S/P	0,07
T-614	Ø32	25332			Ø32	S/P	0,12
T-614	Ø40	25340			Ø40	S/P	0,18
T-614	Ø50	25350			Ø50	S/P	0,27
T-614	Ø63	25363			Ø63	S/P	0,34
T-614	Ø75	25375			Ø75	S/P	1,03
T-614	Ø90	25390			Ø90	S/P	1,49

PRENSA JUNTA FITTING



T-514	Ø20	50970	CIERRES SHUTTER	—	Ø20	100	0,18
T-514	Ø25	50971			Ø25	100	0,20
T-514	Ø32	50972			Ø32	100	0,23
T-514	Ø40	50973			Ø40	100	0,26
T-514	Ø50	50974			Ø50	100	0,38
T-514	Ø63	50975			Ø63	50	0,64
T-514	Ø75	50976			Ø75	40	1,15
T-514	Ø90	50969			Ø90	30	1,39

JUNTA TÓRICA FITTING

ÍNDICE DE CÓDIGOS CODE INDEX

20020	FIT. Enlace Rosca M Ø 20	143	21510	Collarin Ø 50 3/4	145	29175	Válvula Esfera PVC PRESION ENCLAR 075	146	30980	FIT.L. Codo 90° R-M Ø 90	150	50060	T-31-1 T s/curv.ext. 1/2	44	80150	T-225 Manguito H-H PVC flexible Ø50 (300mm)	46
20025	FIT. Enlace Rosca M Ø 25	143	21511	Collarin Ø 50 1/2	145	29180	Válvula Esfera PVC PRESION ENCLAR 090	146	40039	T-39D ME Sifon Ext. DUAL 1/2-1/4 a Ø32-40	95	50061	T-32-F s/curv.ext. Ø70 1/2	45	80151	T-130GB Canaleta con Rejilla PP GRIS	117
20032	FIT. Enlace Rosca M Ø 32	143	21512	Collarin Ø 63 1/2	145	29191	Válvula Esfera PVC PRESION ENCLAR 0110	146	40108	T-30 Clack ME s/curv.ext.Ø70 1/2-1 1/4	91	50062	T-33-F s/curv.ext. 1/2	45	50152	T-150PP Canaleta con Rejilla PP NEGRO 10x100 H60	115
20040	FIT. Enlace Rosca M Ø 40	143	21513	Collarin Ø 63 3/4	145	29220	Válvula Esfera PVC PRESION ENCLAR 0110	146	40109	T-2M Clack ME s/bot.ext.Ø70 1/2-1 1/4	91	50063	T-34 s/curv.lavad. 1/2	44	50153	T-151AG Canaleta PP NEGRO 10x100 H60	115
20060	FIT. Enlace Rosca M Ø 50	143	21514	Collarin Ø 63 1.	145	29225	Válvula Esfera PVC PRESION ROSCAR 3/4.	146	40110	T-60 Clack ME v/lavabo-bide Ø70 1/2	91	50064	T-30M s/curv.ext.Ø70 1/2 MINI	42	50154	T-152AG Rejilla Canaleta A.GALV. 10x100	115
20063	FIT. Enlace Rosca M Ø 63	143	21515	Collarin Ø 63 1/4	145	29232	Válvula Esfera PVC PRESION ROSCAR 1.	146	40111	T-60 Clack ME v/lavabo-bide Ø70 1/4	91	50065	T-30MC s/curv.ext.Ø70 1/2 MINI	43	50155	T-152APP Rejilla Canaleta PP NEGRO 10x100	115
20075	FIT. Enlace Rosca M Ø 75	143	21516	Collarin Ø 63 1/2	145	29237	Válvula Esfera PVC PRESION ROSCAR 1.	146	40193	T-312 ME Plafon Embellecedor Plano Ø10-25 ABIERTO	95	50066	T-31M s/curv.ext. 1/4 - 1	43	50156	T-153AG Tapon para Canaleta PP NEGRO 10x100	115
20090	FIT. Enlace Rosca M Ø 90	143	21517	Collarin Ø 75 1/2	145	29250	Válvula Esfera PVC PRESION ROSCAR 1/2.	146	40245	T-245 ME Válvula Aireacion Intercalable 1/4-Ø32	95	50069	T-11 Sifon Y griega c/alargadera extensible	42	50157	T-160AG Canaleta con Rejilla A.GALV. 13x100 H85	114
20120	FIT. Enlace Rosca H Ø 20	143	21518	Collarin Ø 75 3/4	145	29263	Válvula Esfera PVC PRESION ROSCAR 2.	146	40246	T-245 ME Válvula Aireacion Intercalable 1/2-Ø40	95	50070	T-31S Sifon curvo desplazado 1/2-1 1/4 a Ø40	45	50158	T-161AG Canaleta PP NEGRO 13x100 H85	114
20125	FIT. Enlace Rosca H Ø 25	143	21519	Collarin Ø 75 1.	145	29275	Válvula Esfera PVC PRESION ROSCAR 1/2.	146	40325	T-68 ME Válvula c/reb. Ø70 1/2	93	50071	T-31-L s/curv.Lisos 1/4	44	50159	T-162AG Rejilla A.GALV. 13x100	114
20132	FIT. Enlace Rosca H Ø 32	143	21520	Collarin Ø 75 1/4	145	29290	Válvula Esfera PVC PRESION ROSCAR 3.	146	40326	T-251 Clack ME s/curv.ext.Ø70 1/2-1 1/4 ALA+PLA	91	50072	T-31-S s/curv.Lisos 1/2	44	50160	T-163AG Tapon para Canaleta PP NEGRO 13x100	114
20140	FIT. Enlace Rosca H Ø 40	143	21521	Collarin Ø 75 1/2	145	29291	Válvula Esfera PVC PRESION ROSCAR 4.	146	40327	T-250 Clack ME s/bot.ext.Ø70 1/2-1 1/4 ALA+PLA	91	50076	T-39 1/4. Ø32-40	47	50161	T-164AG Sistema ANTIRROBO para Canaleta 13x100	114
20150	FIT. Enlace Rosca H Ø 50	143	21522	Collarin Ø 75 2.	145	30020	FIT.L. Enlace Rosca M Ø 20	148	40346	T-204 ME Alarg. 1000mm Ø32	96	50077	T-39 1/2. Ø32-40	47	50162	T-164AG Sistema ANTIRROBO para Canaleta 13x100	114
20163	FIT. Enlace Rosca H Ø 63	143	21523	Collarin Ø 90 1/2	145	30025	FIT.L. Enlace Rosca M Ø 25	148	40346	T-204 ME Alarg. 1000mm Ø40	96	50078	T-40 s/bot.laton cr. 1/4 - Ø32	97	50163	T-30MC s/curv.ext.Ø70 1/4 MINI	43
20175	FIT. Enlace Rosca H Ø 75	143	21524	Collarin Ø 90 3/4	145	30032	FIT.L. Enlace Rosca M Ø 32	148	40348	T-204 ME Alarg. 1000mm Ø40	96	50079	T-41 s/curv.laton cr. 1/4 - Ø32	97	50164	T-30M s/curv.ext.Ø70 1/4 MINI	42
20190	FIT. Enlace Rosca H Ø 90	143	21525	Collarin Ø 90 1.	145	30040	FIT.L. Enlace Rosca M Ø 40	148	40348	T-404 ME Alargadura Acodada 700mm + 240mm Ø32	96	50084	T-40-B s/bot.bid.laton cr. 1/4 - Ø32	97	50165	T-132GB Rejilla Conexión 4 Vias PP GRIS	117
20220	FIT. Tapon Final Ø 20	145	21526	Collarin Ø 90 1/4	145	30050	FIT.L. Enlace Rosca M Ø 50	148	40431	T-261 ME Conj. Sifon Curvo Tuerca Local 1/4-1/2	93	50089	T-39-M Ø50-40 / 40-50	46	50166	T-31M s/curv.ext. 1/4 - 1	43
20225	FIT. Tapon Final Ø 25	145	21527	Collarin Ø 90 1/2	145	30063	FIT.L. Enlace Rosca M Ø 63	148	40438	T-31 ME s/curvo 1/2 - 1/2	93	50090	T-39-M Ø50-40 / 40-50	46	50167	T-31M s/curv.ext. 1/4 - 1	43
20232	FIT. Tapon Final Ø 32	145	21528	Collarin Ø 90 2.	145	30075	FIT.L. Enlace Rosca M Ø 75	150	40439	T-31 ME s/curvo 1/2 - 1/2	93	50091	T-300-R s/bot.laton cr. STYLE REDONDO 1/4 - Ø32	97	50168	T-131GB Conexión 4 Vias PP GRIS	117
20240	FIT. Tapon Final Ø 40	145	21529	Collarin Ø 90 2.	145	30090	FIT.L. Enlace Rosca M Ø 90	150	40440	T-4-M ME s/bot 1/2-1/2	93	50092	T-300-C s/bot.laton cr. STYLE CUADRADO 1/4 - Ø32	97	50169	T-134GB Rejilla Canaleta PP GRIS	117
20250	FIT. Tapon Final Ø 50	145	21530	Collarin Ø 90 2.	145	30120	FIT.L. Enlace Rosca H Ø 20	148	40441	T-4-M ME s/bot. 1/4-1/2	93	50093	T-31-TD sifon ext.c/doble toma lavadora	44	50170	T-171 Cuerpo Lineal SPACE con GEO 1,5x2m	73
20263	FIT. Tapon Final Ø 63	145	21531	T-814 Tuerca Fitting Ø25	161	30125	FIT.L. Enlace Rosca H Ø 25	148	40442	T-31 ME s/curvo 1/4 - 1/2	93	50096	TC conv.de sif. 1/4 salida h/60	61	50172	T-171SC Lineal SPACE CURVE con GEO 1,5x2m	72
20275	FIT. Tapon Final Ø 75	145	21532	T-814 Tuerca Fitting Ø30	161	30132	FIT.L. Enlace Rosca H Ø 32	148	40443	T-61 ME valv. Ø 70 1/4	90	50100	T-304N Válvula Click-Clack Laton Pequeña 1/4	37	50173	Lamina GEO en Rollo 1,5x50m (75m2)	78
20290	FIT. Tapon Final Ø 90	145	21533	T-814 Tuerca Fitting Ø32	161	30140	FIT.L. Enlace Rosca H Ø 40	148	40444	T-3-M ME s/bot.Ø70 1/2	92	50101	T-304NR Válvula Click-Clack Laton Pequeño Recambio	37	50174	Lamina GEO en Rollo 1,5x30m (45m2)	78
20320	FIT. Codo 90° Ø 20	144	21534	T-814 Tuerca Fitting Ø36	161	30150	FIT.L. Enlace Rosca H Ø 50	148	40445	T-3-M ME s/bot.Ø70 1/2	92	50102	T-39 1/2 040-50	47	50175	Lamina GEO en Rollo 1,5x10m (15m2)	78
20325	FIT. Codo 90° Ø 25	144	21535	T-814 Tuerca Fitting Ø40	161	30163	FIT.L. Enlace Rosca H Ø 63	148	40446	T-38 ME s/bot.creb.Ø70 1/2	92	50103	T-301N Válvula Click-Clack Laton Normal 1/4	37	50176	Lamina GEO en Corte 1,5x1m (1,5m2)	78
20332	FIT. Codo 90° Ø 32	144	21536	T-814 Tuerca Fitting Ø42	161	30175	FIT.L. Enlace Rosca H Ø 75	150	40447	T-211 ME Plafon Ø40	95	50104	T-301NR Válvula Click-Clack Laton Recambio	37	50177	Lamina GEO en Corte 1,5x2m (3m2)	78
20340	FIT. Codo 90° Ø 40	144	21537	T-814 Tuerca Fitting Ø46	161	30190	FIT.L. Enlace Rosca H Ø 90	150	40448	T-204 ME alarg.250mm Ø32	96	50105	T-105 Membrana Cierre Tapon Click-Clack Laton	159	50178	Lamina GEO en Corte 1,5x3m (4,5m2)	78
20350	FIT. Codo 90° Ø 50	144	21538	T-814 Tuerca Fitting Ø50	161	30220	FIT.L. Deriv. T.R.H Ø 20	148	40449	T-204 ME alarg.500mm Ø32	96	50106	T-302 Válvula Click-Clack Laton c/bas.plast. 1/4	37	50179	T-171SL Lineal SPACE LUXURY con GEO 1,5x2m	72
20363	FIT. Codo 90° Ø 63	144	21539	T-814 Tuerca Fitting Ø50	161	30225	FIT.L. Deriv. T.R.H Ø 25	148	40450	T-204 ME alarg.500mm Ø40	96	50107	T-302 Válvula Click-Clack Laton c/bas.plast. 1/4	37	50180	Lamina PVC en Rollo 1,8x30m (54m2)	78
20375	FIT. Codo 90° Ø 75	144	21540	T-814 Tuerca Fitting Ø50	161	30232	FIT.L. Deriv. T.R.H Ø 32	148	40451	T-204 ME alarg.250mm Ø40	96	50108	T-301-X Repuesto Accionamiento Click-Clack Laton	37	50181	Lamina PVC en Rollo 1,8x10m (18m2)	78
20390	FIT. Codo 90° Ø 90	144	21541	T-814 Tuerca Fitting Ø50	161	30240	FIT.L. Deriv. T.R.H Ø 40	148	40452	T-200 ME Codo H-H 1/2	94	50109	T-30 Clack s/curv.ext.Ø70 1/2	36	50183	T-181R Lineal LINE LAIN 350 con GEO 1,5x2m	75
20420	FIT. T 3 Bocas Ø 20	143	21542	T-814 Tuerca Fitting Ø50	161	30245	FIT.L. Deriv. T.R.H Ø 50	148	40453	T-211 ME Plafon Ø32	95	50110	T-2M Clack s/curv.ext.Ø70 1/2	36	50184	T-181R Lineal LINE LAIN 450 con GEO 1,5x2m	75
20425	FIT. T 3 Bocas Ø 25	143	21543	T-814 Tuerca Fitting Ø50	161	30250	FIT.L. Deriv. T.R.H Ø 63	148	40454	T-250 ME conj.s/bot.Ø70 1/2	92	50111	T-60 Clack v/lavabo-bide Ø70 1/2	36	50185	T-181R Lineal LINE LAIN 550 con GEO 1,5x2m	75
20432	FIT. T 3 Bocas Ø 32	143	21544	T-814 Tuerca Fitting Ø50	161	30263	FIT.L. Deriv. T.R.H Ø 75	151	40455	T-251 ME conj.s/bot.Ø70 1/2	92	50112	T-60 Clack v/lavabo-bide Ø70 1/4	36	50186	T-181R Lineal LINE LAIN 650 con GEO 1,5x2m	75
20440	FIT. T 3 Bocas Ø 40	143	21545	T-814 Tuerca Fitting Ø50	161	30275	FIT.L. Deriv. T.R.H Ø 90	151	40456	T-39 ME 1/4 Ø32-40	95	50113	T-30 Clack s/curv.ext.Ø70 1/2	36	50187	T-181R Lineal LINE LAIN 750 con GEO 1,5x2m	75
20450	FIT. T 3 Bocas Ø 50	143	21546	T-814 Tuerca Fitting Ø50	161	30290	FIT.L. Deriv. T.R.H Ø 90	151	40459	T-39 ME 1/2 Ø32-40	95	50114	T-15 Sifon flexible abierta/ horizontal Ø35	45	50188	T-181R Lineal LINE LAIN 850 con GEO 1,5x2m	75
20463	FIT. T 3 Bocas Ø 63	143	21547	T-814 Tuerca Fitting Ø50	161	30320	FIT.L. Codo 90° Ø 20	149	40462	T-200 ME Codo H-H 1/4	94	50115	T-15 Sifon flexible abierta/ horizontal Ø40	45	50189	T-181R Lineal LINE LAIN 950 con GEO 1,5x2m	75
20475	FIT. T 3 Bocas Ø 75	143	21548	T-814 Tuerca Fitting Ø50	161	30325	FIT.L. Codo 90° Ø 25	149	40463	T-79 ME Desague urinario	94	50116	T-16 Sifon flexible cerrado/ vertical Ø35	45	50190	T-311 Plafon Embellecedor Plano Ø15-25	60
20490	FIT. T 3 Bocas Ø 90	143	21549	T-814 Tuerca Fitting Ø50	161	30332	FIT.L. Codo 90° Ø 32	149	40464	T-79-C ME Desague urinario acodado a/plafon	94	50117	T-16 Sifon flexible cerrado/ vertical Ø40	45	50191	T-311 Plafon Embellecedor Plano Ø32-35	60
20520	FIT. Enlace Recto Ø 20	143	21550	T-814 Tuerca Fitting Ø50	161	30340	FIT.L. Codo 90° Ø 40	149	40471	T-260 ME Conj. Sifon Bot. Tuerca Local 1/4-1/2	93	50118	T-17 Válvula flexible Ø70 p/ sifon flexible Ø35	46	50192	T-311 Plafon Embellecedor Plano Ø40-45	60
20525	FIT. Enlace Recto Ø 25	143	21551	T-814 Tuerca Fitting Ø50	161	30345	FIT.L. Codo 90° Ø 50	149	40805	T-201 ME Codo M-H 1/2	94	50119	T-17 Válvula flexible Ø70 p/ sifon flexible Ø40	46	50193	T-312 Plafon Embellecedor Plano Ø10-25 ABIERTO	60
20532	FIT. Enlace Recto Ø 32	143	21552	T-814 Tuerca Fitting Ø50	161	30363	FIT.L. Codo 90° Ø 63	149	40806	T-201 ME Codo M-H 1/4	94	50120	T-18 Racord 1/4 p/ sifon flex. Ø35	46	50200	T-44 s/dbl.ext. Ø70 1/2	52
20540	FIT. Enlace Recto Ø 40	143	21553	T-814 Tuerca Fitting Ø50	161	30375	FIT.L. Codo 90° Ø 75	150	40806	T-201 ME Codo M-H 1/4	94	50121	T-18 Racord 1/2 p/ sifon flex. Ø35	46	50201	T-44 s/dbl.ext. Ø85 1/2	52
20550	FIT. Enlace Recto Ø 50	143	21554	T-814 Tuerca Fitting Ø50	161	30390	FIT.L. Codo 90° Ø 90	150	40807	T-201 ME Codo M-H 1/2	94	50122	T-181L Lineal LINE LUXURY 350 con GEO 1,5x2m	75	50202	T-44-E s/dbl.ext. Ø115 1/2	52
20563	FIT. Enlace Recto Ø 63	143	21555	T-814 Tuerca Fitting Ø50	161	30425	FIT.L. T 3 Bocas Ø 25	148	40823	T-206 ME Manguito H-H 1/2	94	50123	T-181L Lineal LINE LUXURY 450 con GEO 1,5x2m	75	50203	T-44C BP s/dbl. v/cesta Ø115	55
20575	FIT. Enlace Recto Ø 75	143	21556	T-814 Tuerca Fitting Ø50	161	30432	FIT.L. T 3 Bocas Ø 32	148	40831	T-206 ME Manguito H-H 1/4	94	50124	T-181L Lineal LINE LUXURY 550 con GEO 1,5x2m	75	50204	T-44CR BP s/dbl.v/cesta Ø115	55
20590	FIT. Enlace Recto Ø 90	143	21557	T-814 Tuerca Fitting Ø50	161	30440	FIT.L. T 3 Bocas Ø 40	148	50000	T-2 s/bot.ext.Ø70 1/2	40	50125	T-181L Lineal LINE LUXURY 650 con GEO 1,5x2m	75	50205	T-45 s/dble c/racord 1/2	52
20625	FIT. Enlace Reducido Ø 25-20	143	21558	T-814 Tuerca Fitting Ø50	161	30450	FIT.L. T 3 Bocas Ø 50	148	50002	T-2-E s/bot.ext.Ø115-1/2	40	50126	T-181L Lineal LINE LUXURY 750 con GEO 1,5x2m	75	50206	T-46 s/dbl.ext. Ø70 1/2	52
20632	FIT. Enlace Reducido Ø 32-25	143	21559	T-814 Tuerca Fitting Ø50	161	30463	FIT.L. T 3 Bocas Ø 63	148	50003	T-202 BP valv.cesta Ø115 1/2	54	50127	T-181L Lineal LINE LUXURY 850 con GEO 1,5x2m	75	50207	T-46 s/dbl.ext. Ø85 1/2	52
20640	FIT. Enlace Reducido Ø 40-32	143	21560	T-814 Tuerca Fitting Ø50	161	30475	FIT.L. T 3 Bocas Ø 75	151	50004	T-2CR BP v/cesta Ø115 1/2	55	50128	T-181L Lineal LINE LUXURY 950 con GEO 1,5x2m	75	50208	T-46-E s/dbl.ext. Ø115 1/2	53
20650	FIT. Enlace Reducido Ø 50-40	143	21561	T-814 Tuerca Fitting Ø50	161	30490	FIT.L. T 3 Bocas Ø 90	151	50005	T-2-ER s/bot.ext.c/reb.Ø115 1/2	42	50129	T-181L Lineal LINE LUXURY 350 con GEO 1,5x2m	75	50209	T-47-L s/dbl.c/l.toca 1/2	53
20663	FIT. Enlace Reducido Ø 63-50	143	21562	T-814 Tuerca Fitting Ø50	161	30525	FIT.L. Enlace Recto Ø 20	148	50006	T-2-M s/bot.ext.Ø70 1/4 MINI	40	50130	T-181L Lineal LINE LUXURY 450 con GEO 1,5x2m	75	50210	T-49 s/dbl.ext. Ø70 1/2	53
20675	FIT. Enlace Reducido Ø 75-63	143	21563	T-814 Tuerca Fitting Ø50	161	30532											

50239	T-578T Embellecedor para T-78T	154
50240	T-578BC Embellecedor para T-78BC	84
50241	T-578BN Embellecedor para T-78BN	84
50245	T-245 Valvula Aireacion Intercalable 1/4 - 032	61
50246	T-245 Valvula Aireacion Intercalable 1/2 - 040	61
50250	T-55R Desag.Freg. AHORRO ESPACIO Valv. 070	50
50251	T-55 Desag.Freg. AHORRO ESPACIO Valv. 0115	50
50252	T-55 Desag.Freg. AHORRO ESPACIO Valv. 0115	50
50253	T-55BP Desag.Freg. AHORRO ESPACIO Valv. 0115	50
50254	T-55BM Desag.Freg. AHORRO ESPACIO Valv. 0115	50
50255	T-56R Desag.Freg. Doble AHORRO ESPACIO Valv. 1/2	51
50256	T-56 Desag.Freg. Doble AHORRO ESPACIO Valv. 070	51
50257	T-56 Desag.Freg. Doble AHORRO ESPACIO Valv. 0115	51
50258	T-56BP Desag.Freg. Doble AHORRO ESPACIO Valv. 0115	51
50259	T-56BM Desag.Freg. Doble AHORRO ESPACIO Valv. 0115	51
50263	TAPA WC DEVIA	33
50264	TAPA WC MEDIAS	33
50265	TAPA WC RONDELLA	33
50267	TAPA WC SUACES	31
50268	TAPA WC AROSA	32
50269	TAPA WC ALEGRAZA	32
50277	T-277 Multi-Junta Estanqueidad Tanque FOAM	27
50278	T-278KIT FLUACION (Tom. Inox+Junta Estan. FOAM)	27
50279	T-279 Adaptador para Orificios Gigantes	27
50283	T-181D Lineal LINE DOBLE 350 con GEO 1.5x2m	74
50284	T-181D Lineal LINE DOBLE 450 con GEO 1.5x2m	74
50285	T-181D Lineal LINE DOBLE 550 con GEO 1.5x2m	74
50286	T-181D Lineal LINE DOBLE 650 con GEO 1.5x2m	74
50287	T-181D Lineal LINE DOBLE 750 con GEO 1.5x2m	74
50288	T-181D Lineal LINE DOBLE 850 con GEO 1.5x2m	74
50289	T-181D Lineal LINE DOBLE 950 con GEO 1.5x2m	74
50300	T-60 v/fregador 070 1/2	58
50301	T-60 v/fregador 070 1/4	58
50302	T-303R Planch Emb. Tecno Click-Clack	37
50303	T-303 Tecno Click-Clack	36
50305	T-60-G v/fregador 085 1/2	58
50310	T-61 v/lavabo-bide 070 1/4	58
50315	T-61 v/lavabo-bide 070 1/2	58
50320	T-67 v/plato ducha 085 1/2	84
50323	T-78-BS v/plat.duch. extrabaja SIN EMB. 0115 1/2	81
50325	T-68 v/freg.c/ reb.070 1/2	58
50328	T-81TS Valv.Plat.Ducha Sif.0115 C/TORN. S/EMB T	80
50329	T-81TSM Valv.Plat.Ducha Sif. 0115 C/TORN. S/EMB	79
50330	T-69 v/plat.duch.0115 1/2	58
50331	T-66-P v/plat.duch. 070 - 1/2	85
50335	T-60 v/plat.duch.0115 1/2	58
50339	T-78TM Valv.Plat.Ducha Sif. 0115 C/TORNILLOS	79
50340	T-72 v/cesta c/reb.0115	56
50341	T-72 v/cesta c/reb.085	56
50342	T-75 v/cesta BLANCO c/reb. 0115	56
50343	T-72-R v/cesta c/reb. 0115	56
50344	T-72-R v/cesta c/reb.085	56
50345	T-73 v/cesta inox 0115	56
50346	T-73 v/cesta inox 085	56
50347	T-76 v/cesta BLANCO 0115	57
50349	T-92 tapon v/cesta BLANCO 0115	154
50350	T-93 tapon v/cesta inox 0115	55
50351	T-93 tapon v/cesta inox 085	55
50352	T-72-RBP v/cesta c/reb.p/ plast.0115	57
50353	T-72-RBM v/cesta c/reb.p/ metal 0115	57
50354	T-72 BP v/cesta c/reb.p/ plast.0115	57
50355	T-72 BM v/cesta c/reb.p/ metal 0115	57
50356	T-73-BP v/cesta p/plast. 0115	57
50357	T-73 BM v/cesta p/metal 0115	57
50358	T-93-BP tapon v/cesta p/ plast. 0115	55
50359	T-93 BM tapon v/cesta p/ metal 0115	55
50360	T-84 Codo 360° Sumidero 15x15 050	108
50362	T-84 Codo 360° Sumidero 10x10 040	108
50363	T-201B Codo M-H 1/2 AHORRO	63
50372	T-75 v/cesta MARRON c/ reb. 0115	56
50377	T-76 v/cesta MARRON 0115	57
50379	T-92 tapon v/cesta MARRON 0115	154
50381	T-181 Cuerpo Lineal LINE con GEO 1,5x2m	76
50382	T-75 v/cesta TERRA F. c/reb. 0115	56
50387	T-76 v/cesta TERRA F. 0115	57
50389	T-92 tapon v/cesta TERRA F. 0115	154
50390	T-390 kit Tornillos Expansivos Tapas WC EASY CLICK	30
50395	T-395 kit Tornillos Expansivos Tapas WC INOX CLICK	30
50400	T-61-C v/lav.bidet.oro 070 1/2	90
50401	T-61-C v/lav.bidet.cromo. 070 1/2	90
50402	T-61-BL v/lav.bid.blanco. 070 1/2	90
50403	T-61-B v/lav.bidet.bronce 070 1/2	90
50404	T-61-CO v/lav.bidet.cobre 070 1/2	90
50405	K-62-C kit bañera cromo 070	90
50406	K-62-C kit bañera oro 070	90
50407	K-62-BL kit bañera blanco 070	90
50408	K-62-B kit bañera bronce 070	90
50409	K-62-CO kit bañera cromo 070	90
50410	K-61-C kit lavabo cromo	90
50411	K-61-O kit lavabo oro 070	90
50412	K-61-BL kit lavabo blanco 070	90
50413	K-61-B kit lavabo bronce 070	90
50414	K-61-CO kit lavabo cobre 070	90
50415	T-500-C tapon cromo	160
50416	T-500-BL Tapon blanco	160
50418	T-502-C rejilla valvula cromo	160
50419	T-502-R rejilla valvula oro	160
50420	T-502-BL rejilla valvula blanco	160
50421	T-503-C reb.o.bañera cromo	160
50422	T-503-O reb.o.bañeraoro	160
50423	T-504-C v/lav.bidet.cromo 070 1/4	90
50424	T-504-L embelle.bot.sifon. color	160
50425	T-504-SL embelle.bot. lujo	160
50426	T-61-B v/lav.bidet.bronce 070 1/4	90
50427	T-61-O v/lav.bidet.oro 070 1/4	90
50428	T-61-CO v/lav.bidet.co 070 1/4	90
50429	T-61-BL v/lav.bidet.blanco 070 1/4	90
50430	T-505-C Tornillo cromo 6 x 65	160
50431	T-505-O Tornillo oro 6x65	160
50432	T-505-BL Tornillo blanco 6x65	160
50433	T-506-O cadena oro 27cm.	160
50434	T-506-BL cadena blanco 27 cm.	160
50435	T-506-O cadena oro 42 cm.	160
50436	T-506-BL cadena blanco 42 cm	160
50437	T-506-C cadena cromo 27 cm.	160
50439	T-503-BLRebo.bañera blanco	160
50440	T-88 Sumidero VERTICAL 15x15 050	108
50441	T-86VH Caldereta VH 15x15 050	108
50442	T-88I Sumidero VERTICAL 15x15 050 INOX	109
50443	T-86VH Caldereta VH 15x15 050 INOX	109
50444	T-88D Sumidero VERTICAL 10x10 040 DIAGONAL INOX	111
50445	T-88N Sumidero VERTICAL 10x10 040 LINEAL INOX	111
50446	T-88L Sumidero VERTICAL 10x10 040 LUJO INOX	111
50447	T-88L Sumidero VERTICAL 10x10 040 LUJO ABS	111
50450	T-62 c/bañ. 070 1/2	86
50451	T-62-C c/bañ. coarr. 070 1/2	86
50452	T-88 Sumidero VERTICAL 20x20 0125	108
50454	T-86VHD Caldereta VH 10x10 040 DIAGONAL INOX	111
50455	T-86VHN Caldereta VH 10x10 040 LINEAL INOX	111
50456	T-86VHL Caldereta VH 10x10 040 LUJO INOX	111
50457	T-86VHJ Caldereta VH 10x10 040 LUJO ABS	111
50461	T-361 Valvula H BAJA T/CADENA 070 1/2	59
50462	T-362 Valvula H BAJA TECNO CLICK-CLACK 070 1/2	59
50463	T-363 Valvula H BAJA CLICK-CLACK LATON 070 1/2	59
50464	T-361R Valvula H BAJA + reb T/ CADENA 070 1/2	59
50465	T-362R Valv. H BAJA+reb TECNO CLICK-CLACK 070 1/2	59
50466	T-363R Valv. H BAJA+reb CLICK-CLACK LATON 070 1/2	59
50467	T-361R Valvula H BAJA + reb T/ CADENA 070 1/2	59
50468	T-362R Valv. H BAJA+reb TECNO CLICK-CLACK 070 1/2	59
50469	T-363R Valv. H BAJA+reb CLICK-CLACK LATON 070 1/2	59
50470	T-57R Desag.Freg. AHORRO ESPACIO Valv. 070	50
50471	T-57 Desag.Freg. AHORRO ESPACIO Valv. 0115	50
50472	T-57 Desag.Freg. AHORRO ESPACIO Valv. 0115	50
50473	T-57BP Desag.Freg. AHORRO ESPACIO Valv. 0115	50
50474	T-57BM Desag.Freg. AHORRO ESPACIO Valv. 0115	50
50475	T-58R Desag.Freg.Doble AHORRO ESPACIO Valv. 1/2	51
50476	T-58 Desag.Freg.Doble AHORRO ESPACIO Valv. 0115	51
50477	T-58 Desag.Freg.Doble AHORRO ESPACIO Valv. 0115	51
50478	T-58BP Desag.Freg.Doble AHORRO ESPACIO Valv. 0115	51
50479	T-58BM Desag.Freg.Doble AHORRO ESPACIO Valv. 0115	51
50482	T-86VHA Caldereta VH 10x10 040 INOX + ARO	111
50483	T-86VHA Caldereta VH 10x10 040 LINEAL INOX + ARO	111
50484	T-86VHA Caldereta VH 10x10 040 DIAGONAL INOX + ARO	111
50485	T-86VHA Caldereta VH 10x10 040 LUJO INOX + ARO	111
50486	T-86VHA Caldereta VH 10x10 040 LUJO ABS + ARO	111
50489	T-52R Brazo Freg. AHORRO ESPACIO Valv. 1/2	51
50490	T-52 Brazo Freg. AHORRO ESPACIO Valv. 070	51
50491	T-52 Brazo Freg. AHORRO ESPACIO Valv. 0115	51
50492	T-52BP Brazo Freg. AHORRO ESPACIO Valv. 0115	51
50493	T-52BM Brazo Freg. AHORRO ESPACIO Valv. 0115	51
50494	T-62-C PVC c/bañ. v/coarr. 070 1/2	86
50501	T-63 c/bañ. 070 1/2	86
50505	T-63-C c/bañ.070 1/2	86
50506	T-63-C c/bañ.c/reb./coarr. 070 1/2	86
50510	T-64 conj.bañ.sifon.070 1/2	87
50511	T-64-C c/bañ.sifon.v/coarr. 070 1/2	87
50512	T-64 CL c/bañera click-clack	87
50513	T-80TM Valv.Plat.Ducha Sif. Vertical 0115 C/TORN.	79
50515	T-64-B c/bañ.v/coarr. 070 1/2	87
50520	T-65 v/plato ducha 085 1/2	84
50523	T-80TSM Valv.Plat.Ducha Sif.Vert. 0115 C/TORN.S/EMB	79
50525	T-66 v/plat.duch.sifon.085	84
50526	T-77T Valv.Plat.Ducha Sif. 090 C/TORNILLOS	81
50527	T-77TS Valv.Plat.Ducha Sif. 090 C/TORNILLOS S/EMB	81
50528	T-80T Valv.Plat.Ducha Sif. Vertical 0115 C/TORN.	80
50529	T-80TS Valv.Plat.Ducha Sif.Vert. 0115 C/TORN.S/EMB	80
50530	T-63-B c/bañ.070 1/2	86
50531	T-66-P v/plat.duch. 085 1/2	85
50532	T-66-P v/plat.duch.0115 1/2	85
50533	T-61 v/plat.duch. 085 1/2	84
50534	T-61 v/plat.duch. 0115 1/2	84
50535	T-67 v/plat.duch.enc.0115 1/2	84
50536	T-71 Plat. Ducha Obra PVC 1,8x1,3m STANDARD INOX	70
50537	T-71 Plat. Ducha Obra PVC 1,8x2m STANDARD INOX	70
50538	T-77 v/plat.duch. extrabaja 090 1/2	82
50539	T-78 v/plat.duch. 0115 1/2	82
50541	T-79 desague urinario 1/2	44
50542	T-79-C des.urin.c/platon 1/2	44
50543	T-71 Plat. Ducha Obra PVC 1,8x1,3m LUJO ABS	70
50544	T-71 Plat. Ducha Obra PVC 1,8x2m LUJO ABS	70
50547	T-74 G val.plat.duch. 085	83
50548	T-74 P val.plat.duch. 070	83
50549	T-71G Plat. Ducha Obra GEO 1,5x1,7m STANDARD INOX	71
50550	T-71G Plat. Ducha Obra GEO 1,5x2m STANDARD INOX	71
50551	T-71G Plat. Ducha Obra GEO 1,5x1,7m LUJO ABS	71
50552	T-71G Plat. Ducha Obra GEO 1,5x2m LUJO ABS	71
50555	T-77-A v/plat.duch. 090	82
50556	T-77-B v/plat.duch. 090	82
50563	T-520L Rejilla LUJO INOX 10x10	111
50565	T-132GB Rejilla Conexión 4 Vias PP NEGRO	117
50566	T-71U Plat. Ducha Obra PVC 1,8x1,3m LUJO INOX	70
50567	T-71U Plat. Ducha Obra PVC 1,8x2m LUJO INOX	70
50568	T-71GL Plat. Ducha Obra GEO 1,5x1,7m LUJO INOX	71
50569	T-71GL Plat. Ducha Obra GEO 1,5x2m LUJO INOX	71
50571	Lamina PVC en Corte 1,8x2m 10x10	78
50572	T-571SL Rejilla Lineal SPACE LUXURY 550x82mm	73
50577	T-520D Rejilla DIAGONAL INOX10x10 + Cap.sifónico	111
50578	T-520N Rejilla LINEAL INOX10x10 + Cap.sifónico	111
50579	T-571CS Rejilla Lineal SPACE LUXURY 550x82mm	73
50581	T-71NG Plat. Ducha Obra GEO 1,5x1,7m LUJO INOX	71
50582	T-71NG Plat. Ducha Obra GEO 1,5x2m LINEAL INOX	71
50583	T-71N Plat. Ducha Obra PVC 1,8x1,3m LINEAL INOX	70
50584	T-71N Plat. Ducha Obra PVC 1,8x2m LINEAL INOX	70
50585	T-71DG Plat. Ducha Obra GEO 1,5x1,7m DIAGONAL INOX	71
50586	T-71DG Plat. Ducha Obra GEO 1,5x2m DIAGONAL INOX	71
50587	T-71P Plat. Ducha Obra PVC 1,8x1,3m DIAGONAL INOX	70
50588	T-71P Plat. Ducha Obra PVC 1,8x2m DIAGONAL INOX	70
50600	T-85B Bote Sifónico SUMIDERO (t.expan.)	100
50601	T-88 Sumidero VERTICAL 10x10 040	108
50602	T-86VH Caldereta VH 10x10 040	108
50603	T-133PB Compacto Salida 075-50 c/Tapon CREMA	119
50604	T-86VH Caldereta VH 20x20 0110-90	108
50605	T-85 Bote Sifónico (tapa expansiva)	100
50606	T-85B Bote Sifónico EXTRABAJA-PROLONGAR (t.expan.)	101
50607	T-85C Bote Sifónico EXTRABAJAJO (tapa conica)	101
50608	T-85A Bote Sifónico AIREACION (t.expan.)	100
50609	T-85BS Bote Sifónico EXTRABAJAJO-SUMIDERO (t.expan.)	101
50610	T-90 Mang. Ind. PVC CONCENTRICO 090	102
50612	T-90L Mang. Ind. PVC CONCENTRICO 090 c/junt.lav.	102
50613	T-90E Mang. Ind. PVC CONCENTRICO 090 c/junt.lav.	102
50614	T-90E Mang. Ind. PVC CONCENTRICO 090 c/junt.lav.	102
50615	T-90E Mang. Ind. PVC CONCENTRICO 090	102
50616	T-87LJ Sumidero VH 10x10 050-40 LUJO INOX	110
50617	T-87LJ Sumidero VH 10x10 050-40 LUJO INOX	110
50618	T-89A Tapa EXPANSIVA Bote Sifónico AIREACION	101
50619	T-29A Membrana Descarga	27
50620	T-85BA Bote Sifónico EXTRABAJAJO-AIREACION (t.expan.)	101
50621	T-89S Tapa EXPANSIVA Bote Sifónico SUMIDERO	101
50622	Casquillo Reductor 040-32	127
50623	T-291 Tornillos Fijación Inox	27
50624	T-89E Tapa CONICA Bote Sifónico	101
50625	TAPA WC IBIZA	31
50626	TAPA WC LUCENTUM	32
50627	TAPA WC TABARCA	31
50628	T-86I Caldereta VERTICAL 25x25 0110-90	108
50629	T-86I Caldereta VERTICAL 30x30 0125	108
50630	T-86I Caldereta VERTICAL 20x20 0110-90	108
50631	T-89ST Tubo Flexible TAPA SUMIDERO Bote Sifónico	100
50632	T-88 Sumidero VERTICAL 25x25 0110-90	108
50633	T-88 Sumidero VERTICAL 20x20 0110-90	108
50634	T-451 Grifo Cisterna Alimentacion VERTICAL	25
50635	T-461 Grifo Cisterna Alimentacion HORIZONTAL	25
50636	T-88 Sumidero VERTICAL 15x15 075-50	108
50637	T-87I Sumidero VH 10x10 050-40 INOX	110
50638	T-87 Sumidero VH 10x10 050-40	110
50639	T-86VH Caldereta VH 25x25 0110-90	108
50640	T-86VH Caldereta VH 15x15 075-50	108
50641	T-91 Sombrero Antigrailla Sumidero	110
50642	T-86I Caldereta HORIZONTAL 25x25 090-110	108
50643	T-86I Caldereta HORIZONTAL 20x20 090-110	108
50644	T-88R Rejilla Sumidero PVC 30x30	112
50645	T-88R Rejilla Sumidero PVC 25x25	112
50647	T-88R Rejilla Sumidero PVC 20x20	112
50648	T-88R Rejilla Sumidero PVC 15x15	112
50649	T-88R Rejilla Sumidero PVC 10x10	112
50650	T-292 Junta Estanqueidad Tanque CAUCHO	27
50651	T-130GB Canaleta con Rejilla PP NEGRO	117
50652	T-510 rejilla inox.10X10	111
50653	T-510 rejilla inox. 20X20	155

50830	T-206 manguito reparador Ø40	61
50831	T-206 manguito H-H 1/4	61
50835	T-207 racord c./t. loca Ø32 1/4	62
50836	T-207 racord c./t. loca Ø40 1/2	62
50837	T-207-VA racord c./t. loca	62
50839	T-208 prot.c/tacon c/cad.Ø32	62
50840	T-208 prot.c/tacon c/cad.Ø40	62
50841	T-209-H conex.PVC a t/loc a Ø 40 1/4	64
50842	T-209-H conex.PVC a t/loc a Ø 40-1 1/2	64
50843	T-39 C 1/2 Ø32-40 Corto	47
50846	T-39 C 1/4 Ø32-40 Corto	47
50848	T-209-M conex. PVC	65
50849	T-210 Conexión Toma Lav. SIMPLE Ø40 a 90°	66
50850	T-217 Conv.Interior Tub.PVC Ø32	65
50851	T-211 Plafon Ø32	60
50852	T-211 Plafon Ø40	60
50853	T-209C Conx.Exterior Macho PVC Ø40	65
50855	T-217 Conv.Interior Tub.PVC Ø40	65
50860	T-212 reb.fregadero	62
50861	T-213 conex. c./t.lavad.Ø40	62
50862	T-214 conex.c./t.lavad.Ø40	62
50863	T-215 alarg.falx. solda PVC Ø 40	63
50864	T-216 Conexión Toma Lav. DOBLE Ø40 a 90°	66
50867	T-291K KIT Fijación (Torn. Inox.+Junta Estanq.CAUCHO)	27
50869	T-282P Pulsador Doble para T-282	27
50874	T-289 Mec.Simple Desc. p/ brador + KIT	22
50875	T-289S Mec.Simple Desc. p/ brador	22
50877	T-281P Pulsador Simple para T-281	27
50878	T-289T Tirador para T-289	27
50880	T-289R Mec.Simple Desc. p/ brador SIN TIRADOR/BASE	22
50881	T-88VH Sumidero VH 360° 10x10 Ø40	108
50882	T-88VH Sumidero VH 360° 15x15 Ø50	108
50883	T-88VH Sumidero VH 360° 20x20 Ø110-90	108
50884	T-88VH Sumidero VH 360° 25x25 Ø110-90	108
50885	T-88VH Sumidero VH 360° 20x20 Ø110-90 INOX	109
50886	T-280P Pulsador Doble para T-280	27
50887	T-88VH Sumidero VH 360° 15x15 Ø50 INOX	109
50888	T-293 Adaptador Bases Rosca	27
50889	T-293SS Mec.Simple Desc. p/ brador SIN TIRADOR	22
50890	T-88VH Sumidero VH 360° 10x10 Ø40 STANDARD INOX	109
50891	T-88VH Sumidero VH 360° 10x10 Ø40 LINEAL INOX	111
50892	T-88VH Sumidero VH 360° 10x10 Ø40 DIAGONAL INOX	111
50893	T-88VH Sumidero VH 360° 10x10 Ø40 LUJO INOX	111
50894	T-88VH Sumidero VH 360° 10x10 Ø40 LUJO ABS	111
50895	T-295 Campana Base Mecanismos	27
50896	T-296 Base Mecanismos	27
50897	T-297 Junta Base Mecanismos	27
50898	T-298 Membrana Grifo Alimentación	27
50899	T-299 Filtro Grifo Cisterna	27
50900	T-500 Tapon fregadero	154
50901	T-500-A Tapon freq.c/asa	154
50902	T-94 Tapon val.automatica	154
50905	T-501 Tapon c/cadena 270 mm.	155
50906	T-501 Tapon c/cadena 380 mm.	155
50910	T-502 rejilla inox. 1/2 Ø65	155
50911	T-502 rejilla inox. 1/2 Ø70	155
50912	T-502 rejilla inox. Ø85	155
50913	T-502 Rejilla inox Ø115	155
50915	T-503 reb.bañera inox.	155
50920	T-504 Embellecedor Bote Sifónico	155
50921	T-504S Embellecedor Bote Sifónico/Sumidero	155
50925	T-505 tornillo inox 6x20	157
50926	T-505 tornillo inox 6x35	157
50927	T-505 tornillo inox 6x65	157
50928	T-505 tornillo inox 6x45	157
50929	T-505 tornillo inox 6x55	157
50930	T-506 cadena 270 mm.	157
50931	T-506 cadena 380 mm.	157
50932	T-505 Tornillo 6x75	157
50935	T-507 junta conica 1.	158

50936	T-507 junta conica 1/4	158
50937	T-507 junta conica 1/2	158
50938	T-515 Junta conica para asiento conico Ø115	161
50939	T-515 Junta conica para asiento conico Ø85	161
50940	T-508 junta conica reduct. 40-32	158
50941	T-505 Tornillo 3,5x19	157
50942	T-505 Tornillo 3,5x25	157
50944	T-505 Tornillo 4,8x25	157
50945	T-505 Tornillo 4,8x32	157
50946	T-516 rejilla inox.val.plat. ducha Ø85	157
50947	T-516 rejilla inox.val.plat. ducha Ø115	157
50948	T-516 rejilla inox.val.plat. ducha Ø70	157
50949	T-87R Rejilla Sumidero T-87 PVC 10x10	112
50950	T-509 junta racord 1/4	158
50951	T-509 junta racord 1/2	158
50953	T-512 Junta plana Ø65	158
50954	T-512 Junta Plana Ø70	158
50955	T-512 Junta plana Ø85	158
50956	T-512 Junta plana Ø115	158
50960	T-513 Junta base labiada Ø70	158
50963	T-513 Junta base labiada Ø85	158
50962	T-513 Junta base labiada Ø90	158
50963	T-513 Junta base labiada Ø115	158
50967	T-518 Tuerca Blanca 1/2	159
50968	T-518 Tuerca Blanca 1/4	159
50969	T-514 Junta tórica Ø 90	161
50970	T-514 Junta tórica Ø 20	161
50971	T-514 Junta tórica Ø 25	161
50972	T-514 Junta tórica Ø 32	161
50973	T-514 Junta tórica Ø 40	161
50974	T-514 Junta tórica Ø 50	161
50975	T-514 Junta tórica Ø 63	161
50976	T-514 Junta tórica Ø 75	161
50977	T-539 Junta Plana Converter 1 1/2 a 1 1/4	158
50978	T-339 Kit Converter 1 1/2 a 1 1/4	159
50979	T-439 Kit Converter 1 1/2 a 1 1/4	159
50987	T-86VI Caldereta VERTICAL 15x15 Ø90 INOX	109
50988	T-86VI Caldereta VERTICAL 10x10 Ø40 INOX	109
50989	T-518 Tuerca Blanca 1.	159
50997	T-519 Tuerca Metalizada 1/2	159
50998	T-519 Tuerca Metalizada 1/4	159
50999	T-519 Tuerca Metalizada 1.	159
52000	Codo H-H 87° Ø32	123
52001	Codo H-H 87° Ø40	123
52002	Codo H-H 87° Ø50	123
52003	Codo H-H 87° Ø90	123
52005	Codo H-H 87° Ø110	123
52006	Codo H-H 87° Ø125	123
52007	Codo H-H 87° Ø160	123
52008	Codo H-H 87° Ø110 2T Ø40	124
52009	Codo H-H 87° Ø110 2T Ø50	124
52010	Codo M-H 87° Ø32	122
52011	Codo M-H 87° Ø40	122
52012	Codo M-H 87° Ø50	122
52013	Codo M-H 87° Ø75	122
52014	Codo M-H 87° Ø90	122
52015	Codo M-H 87° Ø110	122
52016	Codo M-H 87° Ø125	122
52017	Codo M-H 87° Ø160	122
52018	Codo M-H 87° Ø200	122
52019	Codo M-H 87° Ø250	122
52020	Codo H-H 45° Ø32	124
52021	Codo H-H 45° Ø40	124
52022	Codo H-H 45° Ø50	124
52023	Codo H-H 45° Ø75	124
52024	Codo H-H 45° Ø90	124
52025	Codo H-H 45° Ø110	124
52026	Codo H-H 45° Ø125	124
52027	Codo H-H 45° Ø160	124
52028	Codo H-H 45° Ø200	124
52029	Codo H-H 45° Ø250	124
52030	Codo M-H 45° Ø32	122
52031	Codo M-H 45° Ø40	122
52032	Codo M-H 45° Ø50	122
52033	Codo M-H 45° Ø75	122
52034	Codo M-H 45° Ø90	122
52035	Codo M-H 45° Ø110	122
52036	Codo M-H 45° Ø125	122
52037	Codo M-H 45° Ø160	122

52038	Codo M-H 45° Ø200	122
52039	Codo M-H 45° Ø250	122
52040	Codo M-H 45° Ø315	122
52041	Deriv. M-H 45° Ø40	125
52042	Deriv. M-H 45° Ø50	125
52043	Deriv. M-H 45° Ø75	125
52044	Deriv. M-H 45° Ø90	125
52045	Deriv. M-H 45° Ø110	125
52046	Deriv. M-H 45° Ø125	125
52047	Deriv. M-H 45° Ø160	125
52048	Deriv. M-H 45° Ø200	125
52049	Deriv. M-H 45° Ø250	125
52050	Deriv. M-H 45° Ø32	126
52051	Deriv. H-H 45° Ø40	126
52052	Deriv. H-H 45° Ø50	126
52053	Deriv. H-H 45° Ø75	126
52054	Deriv. H-H 45° Ø90	126
52055	Deriv. H-H 45° Ø110	126
52056	Deriv. H-H 45° Ø125	126
52057	Deriv. H-H 45° Ø160	126
52058	Deriv. H-H 45° Ø200	126
52059	Deriv. H-H 45° Ø250	126
52060	Deriv. M-H 87° Ø32	124
52061	Deriv. M-H 87° Ø40	124
52062	Deriv. M-H 87° Ø50	124
52063	Deriv. M-H 87° Ø75	124
52064	Deriv. M-H 87° Ø90	124
52065	Deriv. M-H 87° Ø110	124
52066	Deriv. M-H 87° Ø125	124
52067	Deriv. M-H 87° Ø160	124
52068	Deriv. M-H 87° Ø200	124
52069	Deriv. M-H 87° Ø250	124
52070	Deriv. H-H 87° Ø32	126
52071	Deriv. H-H 87° Ø40	126
52072	Deriv. H-H 87° Ø50	126
52073	Deriv. H-H 87° Ø110	126
52074	Deriv. H-H 87° Ø125	126
52075	Deriv. H-H 87° Ø160	126
52077	Deriv. H-H 87° Ø200	126
52078	Codo H-H 87° Ø 200	123
52079	Codo H-H 87° Ø250	123
52080	Codo H-H 87° Ø315	123
52088	Deriv. H-H 87° Ø250	126
52089	Deriv. H-H 87° Ø315	126
52101	Deriv. H-H 45° Ø315	126
52102	Manguito Rep. M-H Ø110 1T 45° Ø50	130
52103	Manguito Rep. M-H Ø90 1T 87° Ø40	130
52104	Manguito Rep. M-H Ø110 1T 87° Ø50	130
52105	Manguito Rep. M-H Ø125 1T 87° Ø50	130
52106	Manguito Rep. M-H Ø110 2T 87° Ø50	131
52110	Codo M-H 87° Ø90 1T Ø50	123
52111	Codo M-H 87° Ø110 1T Ø50	123
52113	Codo H-H 87° Ø110 122	122
52114	Codo M-H 22° Ø125	122
52115	Reduc. Exc. M-H Ø40-32	129
52116	Reduc. Exc. M-H Ø50-32	129
52117	Reduc. Exc. M-H Ø50-40	129
52118	Reduc. Exc. M-H Ø125-50	129
52119	Reduc. Exc. M-H Ø125-110	129
52120	Codo M-H 87° Ø315	122
52121	Reduc. Exc. M-H Ø160-110	129
52122	Codo M-H 67° Ø200	122
52123	Reduc. Exc. M-H Ø160-125	129
52124	Reduc. Exc. M-H Ø200-125	129
52125	Codo H-H 87° Ø125 2T Ø50	124
52126	Reduc. Exc. M-H Ø200-160	129
52127	Reduc. Exc. M-H Ø250-200	129
52128	Reduc. Exc. M-H Ø315-200	129
52129	Reduc. Exc. M-H Ø315-250	129
52130	Codo H-H 45° Ø315	124
52131	Manguito H-H Ø 200	127
52132	Manguito H-H Ø 32	127
52133	Manguito H-H Ø 40	127
52134	Manguito H-H Ø 50	127
52135	Manguito H-H Ø 75	127
52136	Manguito H-H Ø 90	127
52137	Manguito H-H Ø 110	127
52138	Manguito H-H Ø 125	127
52139	Manguito H-H Ø 160	127
52140	Reduc. Exc. Com. H-M Ø 75-40	128
52141	Reduc. Exc. Com. H-M Ø 75-50	128

52142	Reduc. Exc. Com. H-M Ø 90-50	128
52143	Reduc. Exc. Com. H-M Ø 90-75	128
52144	Reduc. Exc. Com. H-M Ø 110-75	128
52145	Reduc. Exc. Com. H-M Ø 110-90	128
52146	Reduc. Exc. Com. H-M Ø 125-90	128
52147	Reduc. Exc. Com. H-M Ø 125-110	128
52148	Reduc. Exc. Com. H-M Ø 160-110	128
52149	Reduc. Exc. Com. H-M Ø 160-125	128
52150	Reduc. Exc. Com. H-M Ø 200-125	128
52152	Tapon Macho Ø40	129
52153	Tapon Macho Ø50	129
52154	Tapon Macho Ø75	129
52155	Tapon Macho Ø90	129
52156	Tapon Macho Ø110	129
52157	Tapon Macho Ø125	129
52158	Tapon Macho Ø160	129
52159	Tapon Macho Reducido Ø110 3T Ø50-40-40	128
52160	Tapon Macho Reducido Ø125 4T Ø50-40-40-40	127
52161	Tapon Final c/registro Ø40	129
52162	Tapon Final c/registro Ø50	129
52163	Tapon Final c/registro Ø75	129
52164	Tapon Final c/registro Ø90	129
52165	Tapon Final c/registro Ø110	129
52166	Tapon Final c/registro Ø125	129
52167	Tapon Final c/registro Ø160	129
52168	Inj.c/abraz.Elast.Ø 110-40	130
52169	Inj.c/abraz.Elast.Ø 110-50	130
52170	Inj.c/abraz.Elast.Ø 125-40	130
52171	Inj.c/abraz.Elast.Ø 125-50	130
52172	Injerto Abrazadera Ø90-40	130
52173	Injerto Abrazadera Ø90-50	130
52175	Manguito Reparación Ø110 a Interior Tubo PVC	131
52176	Manguito Reparación Ø125 a Interior Tubo PVC	131
52177	Reduc. Exc. Com. H-M Ø 200-160	128
52182	Tapon macho Ø200	129
52183	Tapon macho Ø250	129
52184	Tapon macho Ø315	129
52185	Manguito Rep. M-H Ø90	131
52186	Manguito Rep. M-H Ø110	131
52187	Manguito Rep. M-H Ø125	131
52188	Manguito Rep. M-H Ø160	131
52189	Tapon final c/registro Ø200	129
52190	Codo M-H 87° Ø90 2T Ø50	123
52191	Codo M-H 87° Ø110 2T Ø50	123
52192	Codo M-H 87° Ø125 2T Ø50	123
52195	Tapon final c/registro Ø250	129
52196	Tapon final c/registro Ø32	129
52198	Manguito H-H Ø250	127
52199	Manguito H-H Ø315	127
52200	Tapon final c/registro Ø315	129
52203	Codo H-H 67° Ø125	122
52204	Deriv. Doble H-H 45° Ø40	127
52206	Codo M-H 67° Ø32	122
52207	Codo M-H 67° Ø40	122
52208	Codo M-H 67° Ø50	122
52209	Codo H-H 67° Ø32	122
52210	Codo H-H 67° Ø40	122
52211	Codo H-H 67° Ø50	122
52212	Codo H-H 67° Ø90	122
52213	Reduc. Exc. M-H Ø160-125	129
52214	Reduc. Exc. M-H Ø200-125	129
52215	Codo H-H 87° Ø125 2T Ø50	124
52216	Reduc. Exc. M-H Ø200-160	129
52217	Reduc. Exc. M-H Ø250-200	129
52218	Reduc. Exc. M-H Ø315-200	129
52219	Reduc. Exc. M-H Ø315-250	129
52223	Sifon con registro M-H Ø110	133
52224	Sifon con registro M-H Ø125	

NOTAS

A large rectangular area with a thick orange border, containing 20 horizontal dotted lines for writing notes.



- Apilación Compacta.
- Sistema de Trabado.
- Se adapta a palet europeo.
- Altura embalajes múltiples.
- Bases unificadas.
- Familias diferenciadas por colores.

	MEDIDAS				M	S	P	F	I	L
	LAR.	ANC.	ALT.	M³						
1	590	390	700	0,166						
2	590	390	350	0,083						
3	590	390	175	0,042						
4	390	195	175	0,014						
5	1100	100	180	0,020						
6	400	200	150	0,016						
7	217	205	127	0,006						
8	1500	200	200	0,060						
9	1800	200	200	0,072						
0	370	370	165	0,023						

CONDICIONES GENERALES

- Las operaciones de compraventa sea cual sea el lugar de entrega de la mercancía, se entienden realizadas en el domicilio social de HIDROTECNOAGUA, S.L., por lo tanto ambas partes aceptan la competencia de los Juzgados y Tribunales de Alicante con renuncia de su propio fuero y domicilio.
- Portes pagados para pedidos superiores a 500€ netos a cualquier destino nacional peninsular. Los pedidos inferiores a 500€ netos tendrán un cargo de 12€ en concepto de transporte. Para cualquier otro destino rogamos consulten condiciones con anterioridad.
- Cargo por picking, es decir, si no se respetan las unidades caja establecidas:
 - De 1 a 5 referencias cargo del 5%.
 - De 5 a 10 referencias cargo del 10%.
 - De 10 a 15 referencias cargo del 15%.
 - Para más de 15 referencias cargo del 20%.
- Se suministrara cualquier componente que fabriquemos suelto, aún sin estar referenciado en el catálogo vigente.
- HIDROTECNOAGUA, S.L., se reserva el derecho a modificar diseños, medidas, precios, embalajes y otros conceptos de los productos para la mejora de los mismos, sin previo aviso.

DEVOLUCIONES DE MATERIAL

- No se admiten devoluciones de material salvo autorización expresa de la fábrica. No obstante cualquier devolución autorizada siempre deberá ser de cajas completas en perfecto estado. La fábrica se reserva el derecho a realizar un cargo por demérito y manipulación del material.

GARANTÍAS

- Nuestros artículos son garantizados de todo defecto de fabricación. Esta Garantía queda limitada única y exclusivamente a la sustitución del material que sea considerado como defectuoso.
- Garantía 1 año

IMPORTANTE

- Los platos de ducha deberán estar no integrados en la obra siendo su fijación a ella mediante un elastómero tipo sicaflex que facilita el acceso al sifonaje sin necesidad de dañar el revestimiento de la obra.
- Las bañeras deberán estar como el anterior, sellado y no integrado en la obra, y además provista de un registro de acceso al elemento de desagüe y rebosadero, de tal manera que su sustitución se pueda efectuar sin dañar ninguna parte de la obra.

*Edita: Tecnoagua
Dirección: Rafael Morán
Diseño y Maquetación: Rafael Morán
Fotografías: Tecnoagua
Impresión: INGRA Impresores*

TECNOAGUA
Design



TECNOAGUA

Design

Avda. del Rodalet, 20 - Apdo. 296 - 03690 San Vicente del Raspeig · Alicante · España
TLF +34 96 567 26 11 · +34 96 567 41 69 · FAX +34 96 566 33 67
info@hidrotecnoagua.com · www.hidrotecnoagua.com

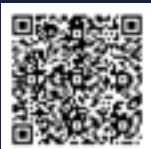

CONECTA CON NOSOTROS

